

WTVF-VF1-V1.1-5

更

恒达富士电梯

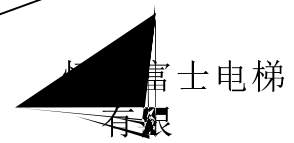

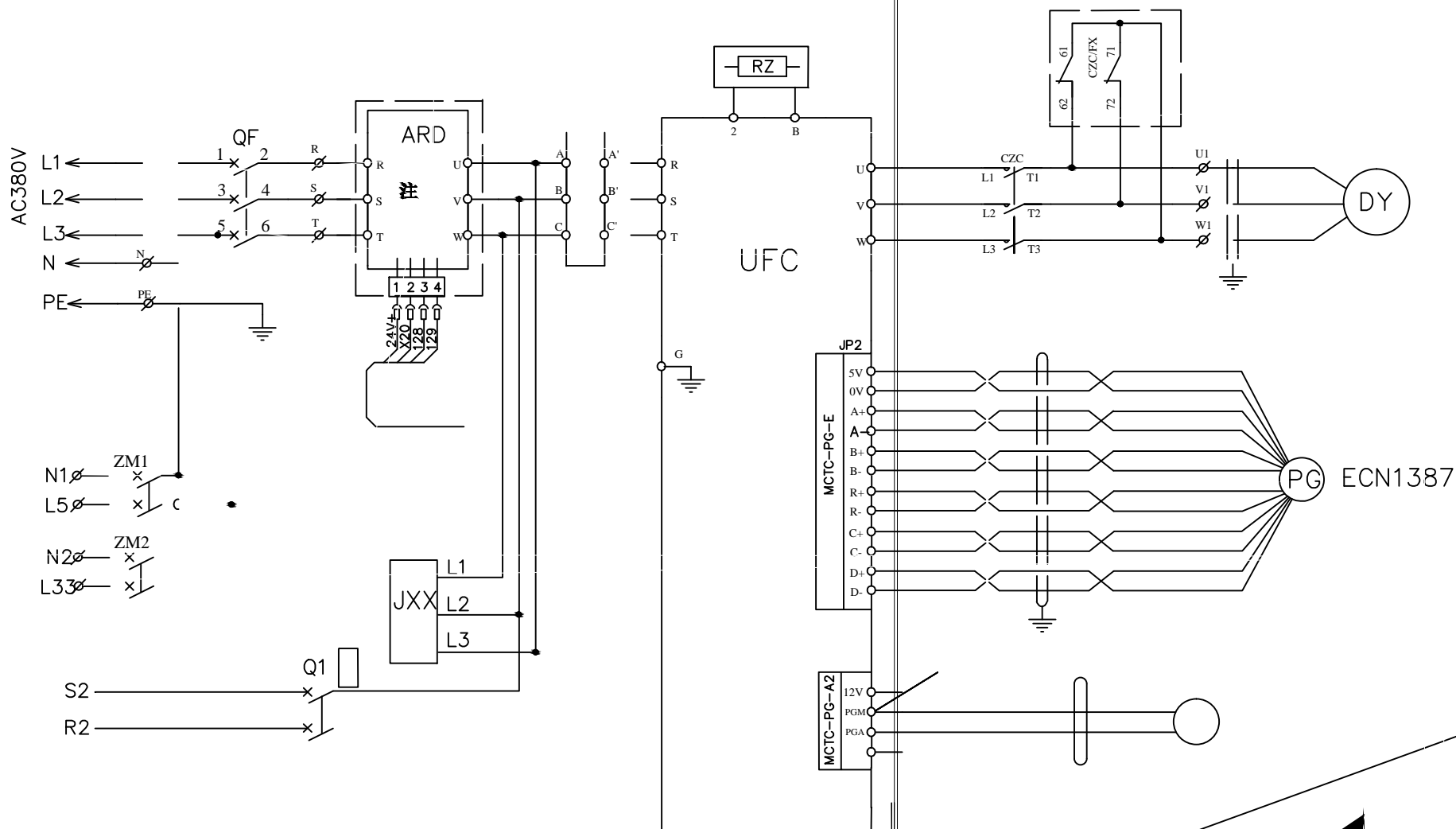

更改文件号

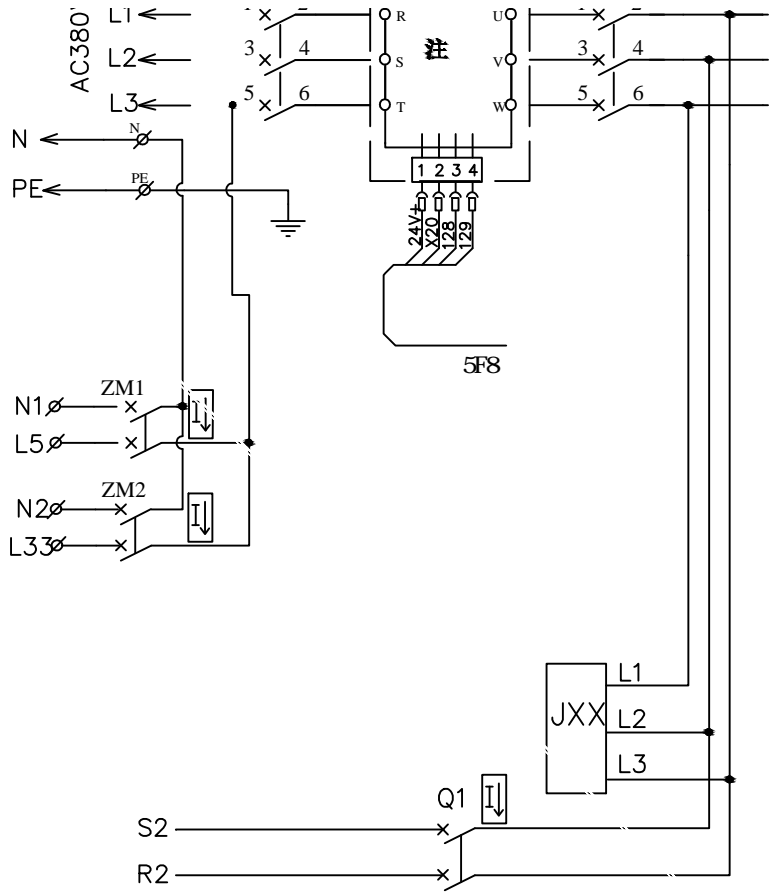

NA%
 NA&
 E%
 5F8
 5F8
 % ?
 & IH

%?K

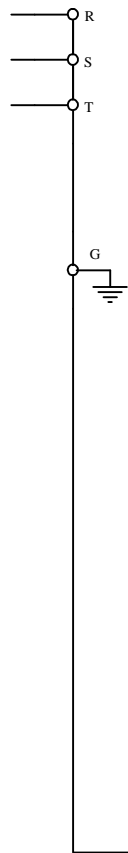

UFC

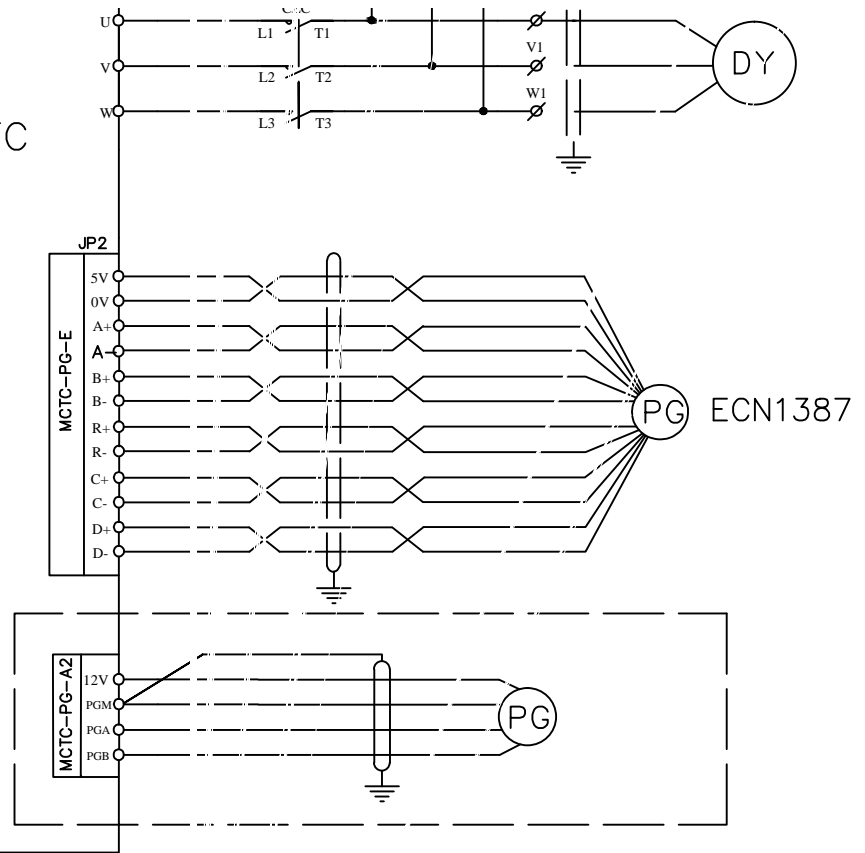

更改文件号



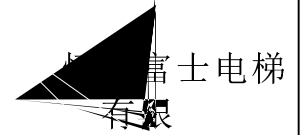
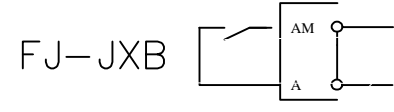
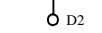
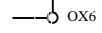
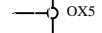
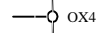
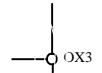
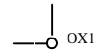
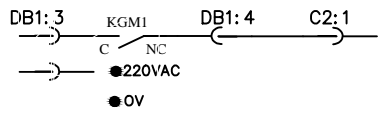

更改文件号

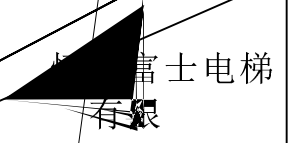
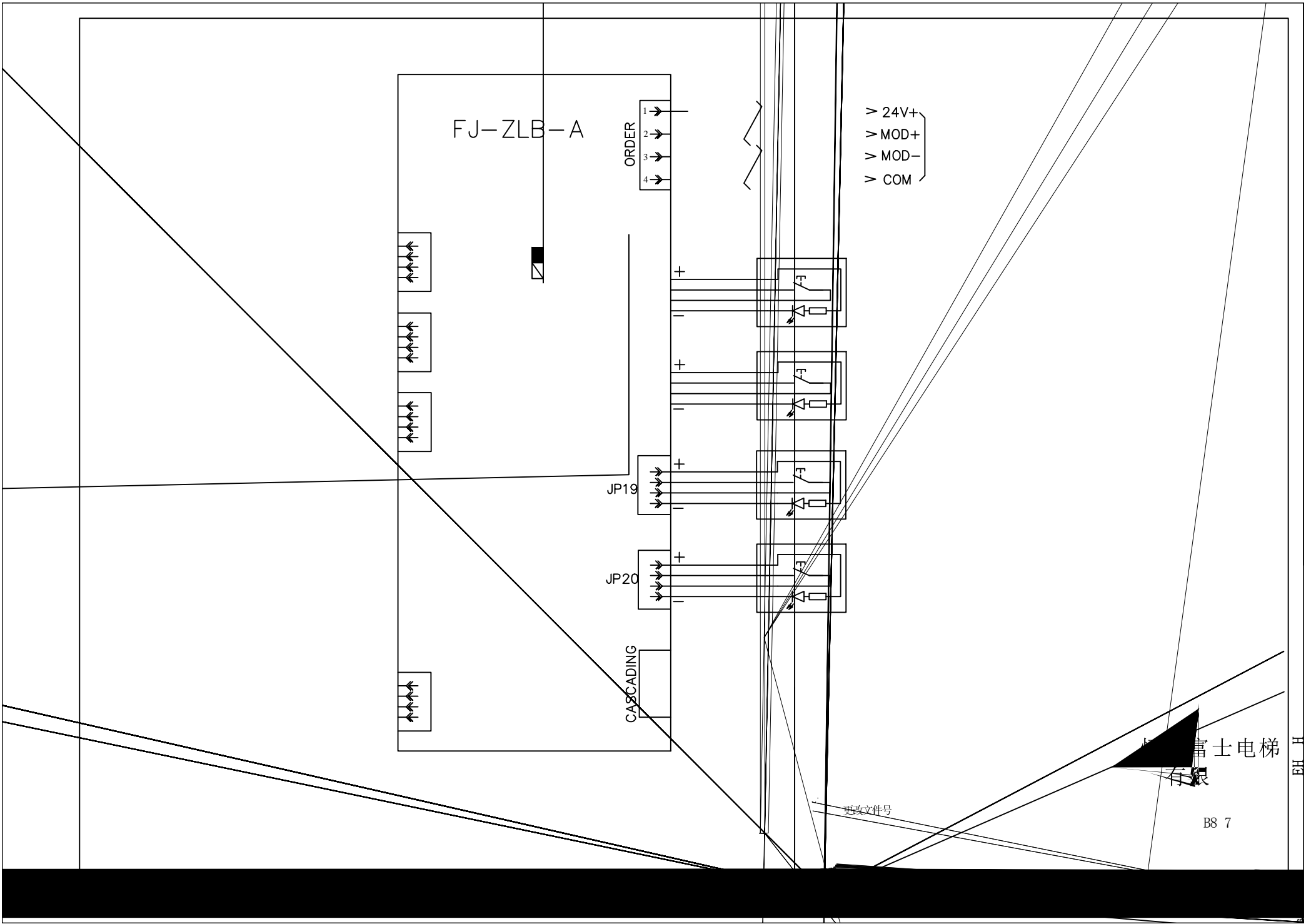

更改文件号

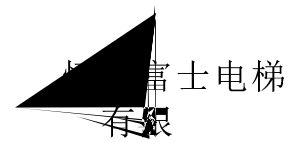

更改文

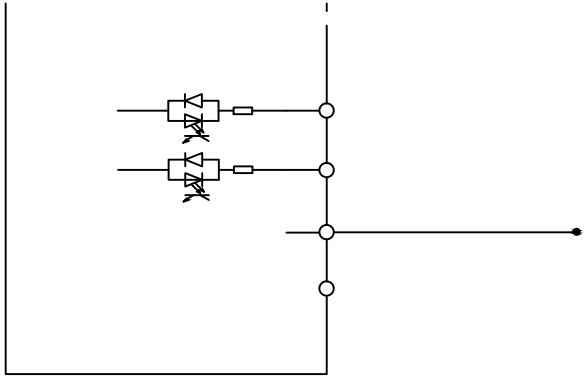

.

.

.

.

.

.

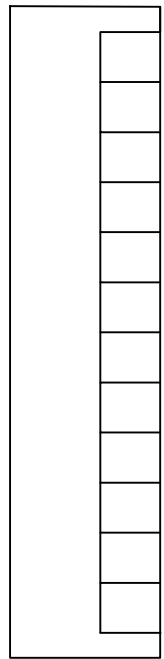
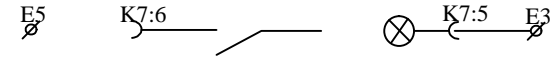
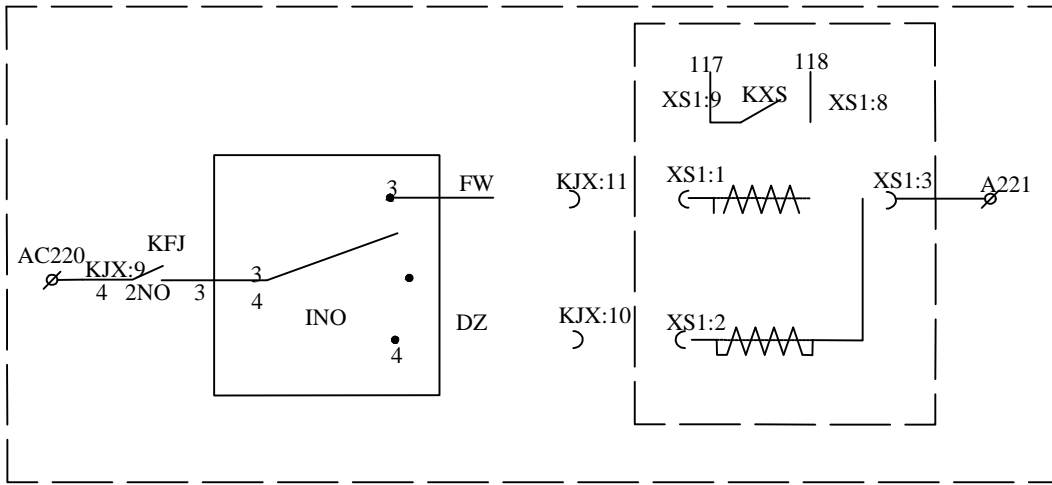

CK1:1
C

∅ BK2

/BK1



恒达

更改文件号

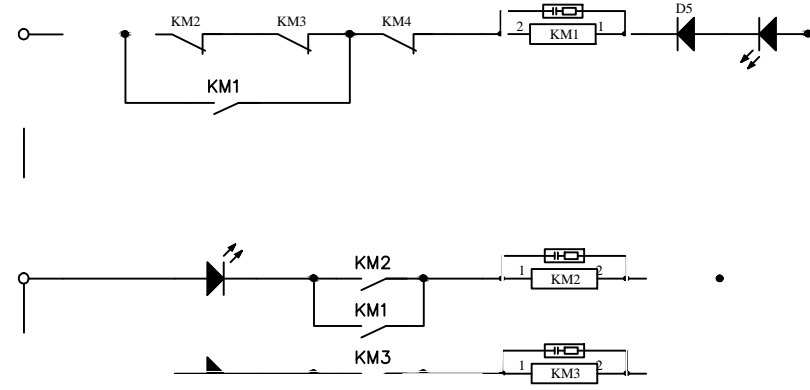

FJ-MPU-V4.0

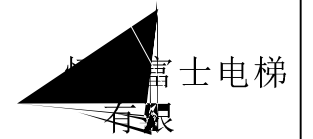

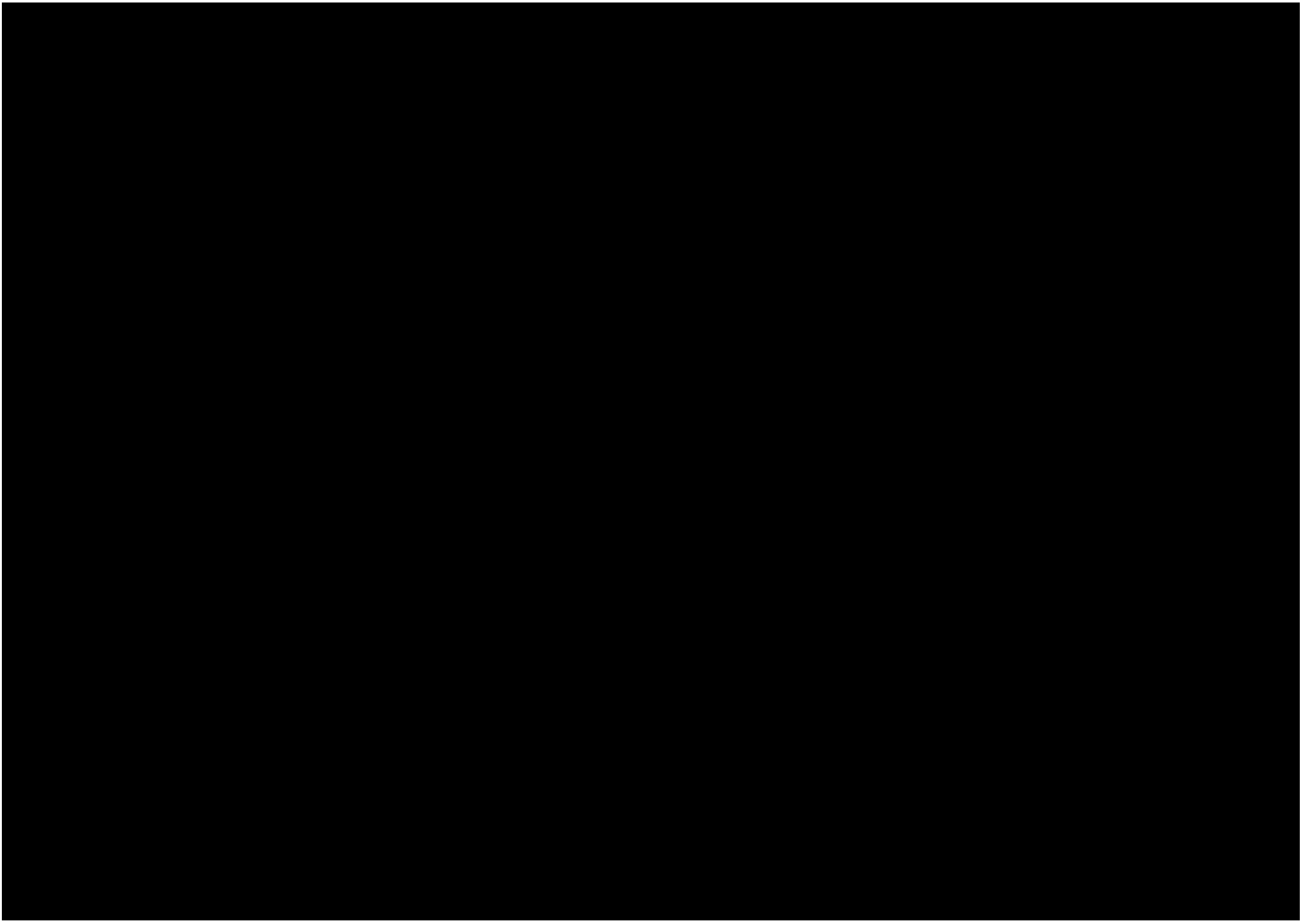

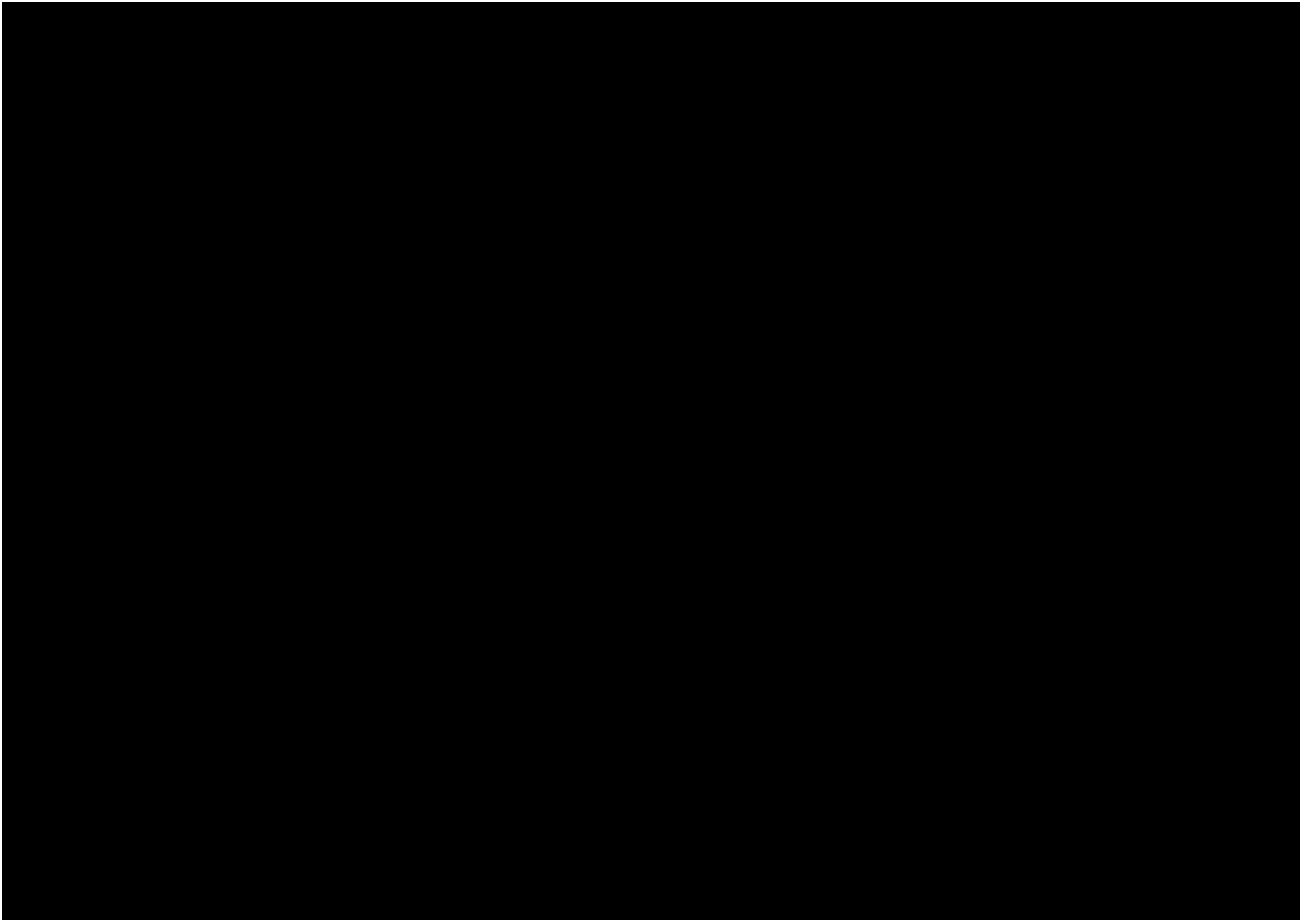

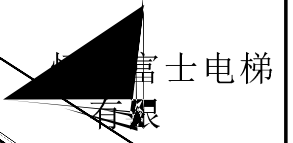
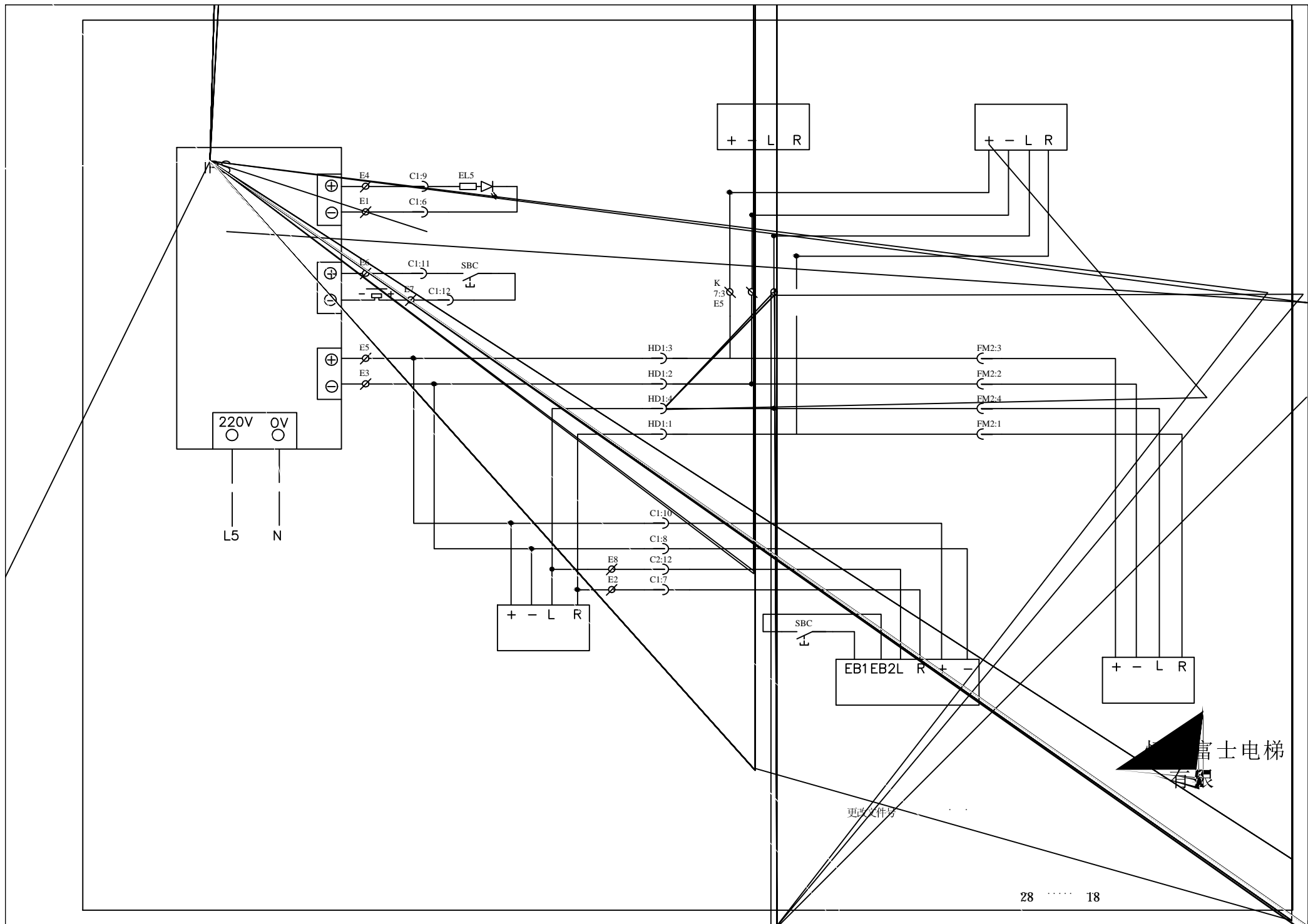

更改文件号

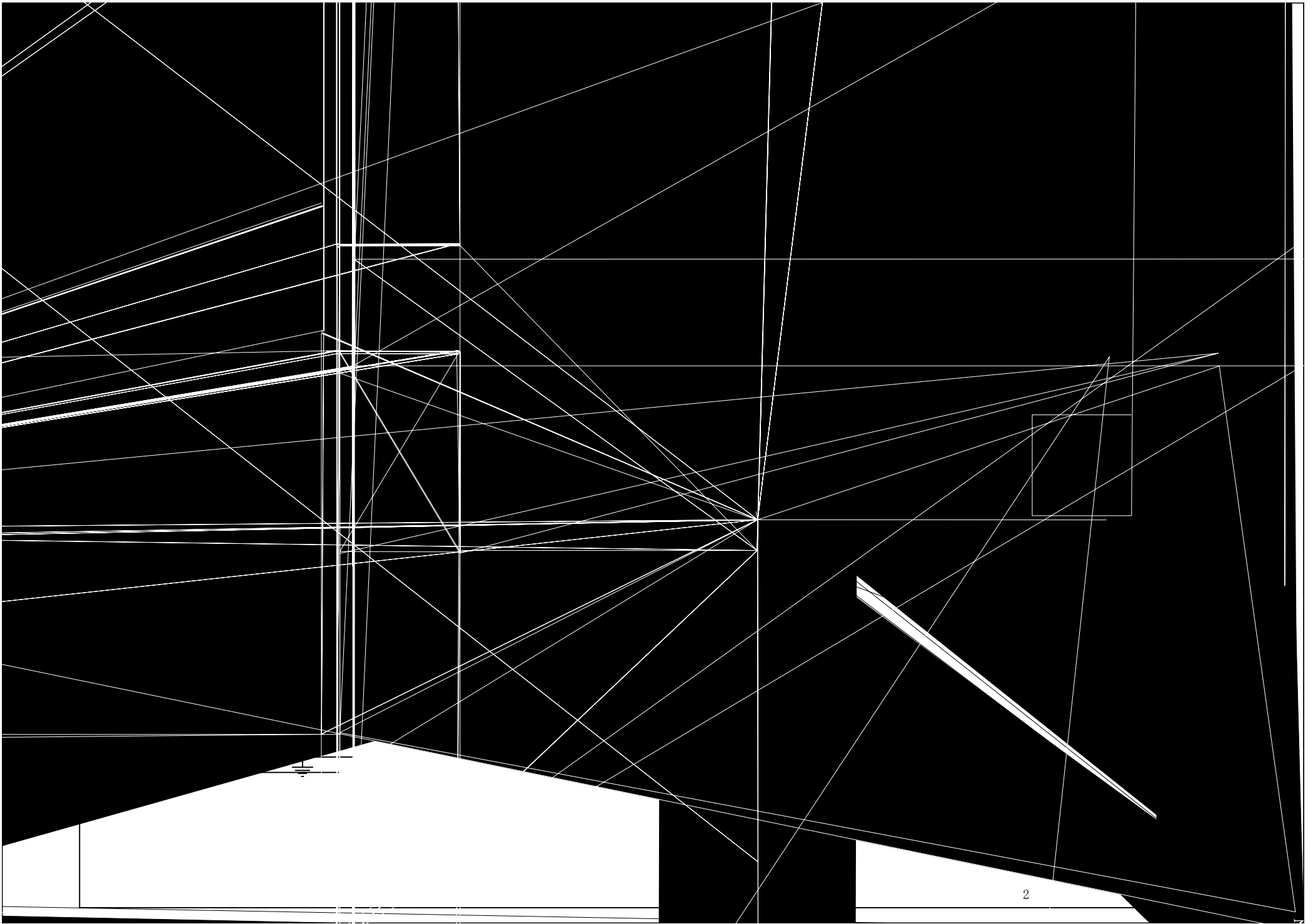

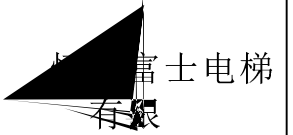
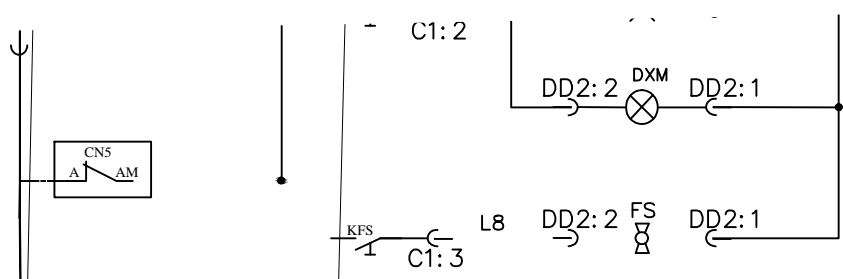

标记	处数	分区	更改文件号	签名	年月日		
设计			标准化			阶段标识	重量 比例
校对							
审核							
工艺			批准			共28张	第20张

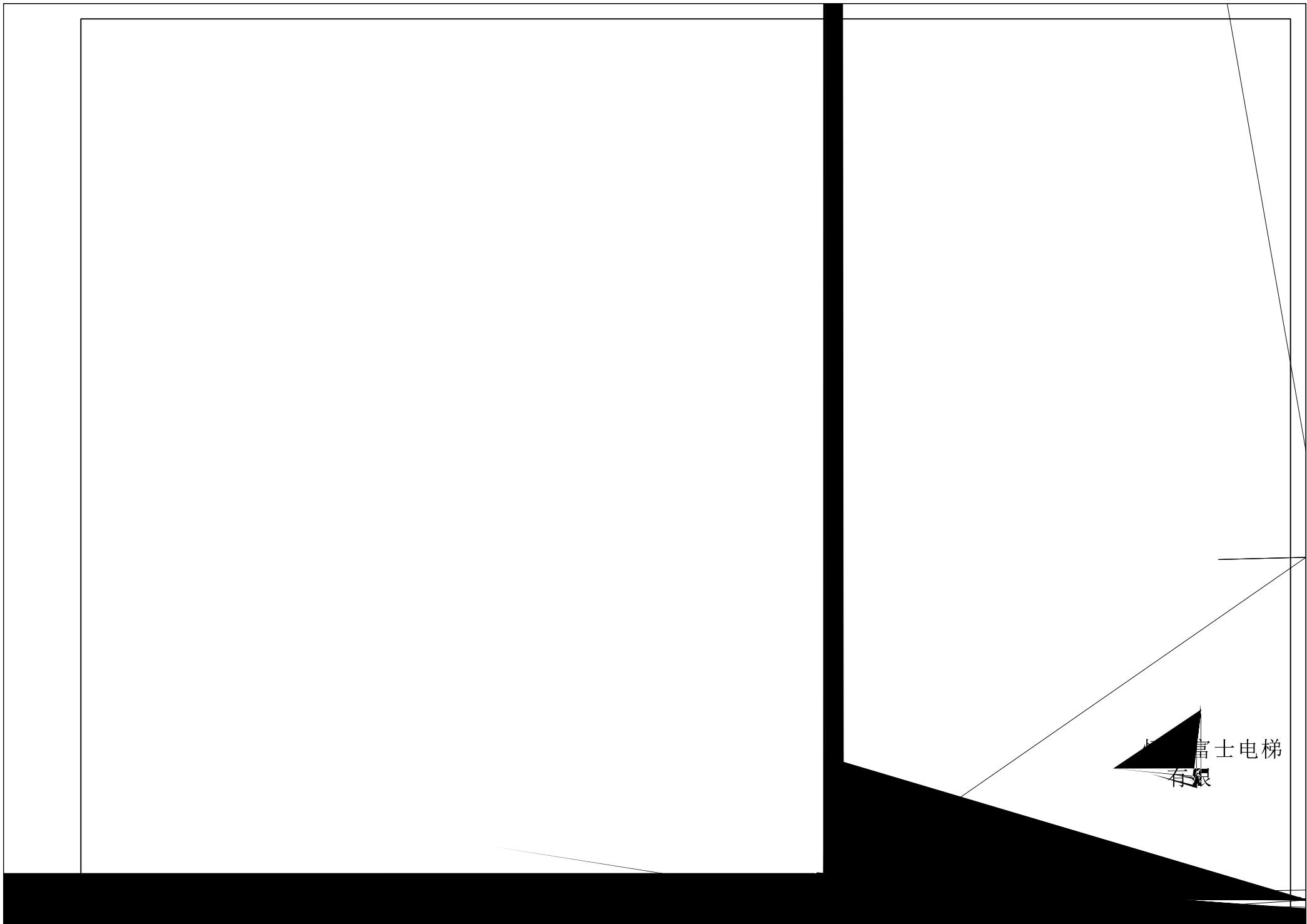

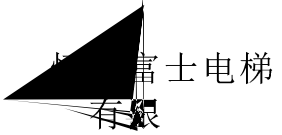
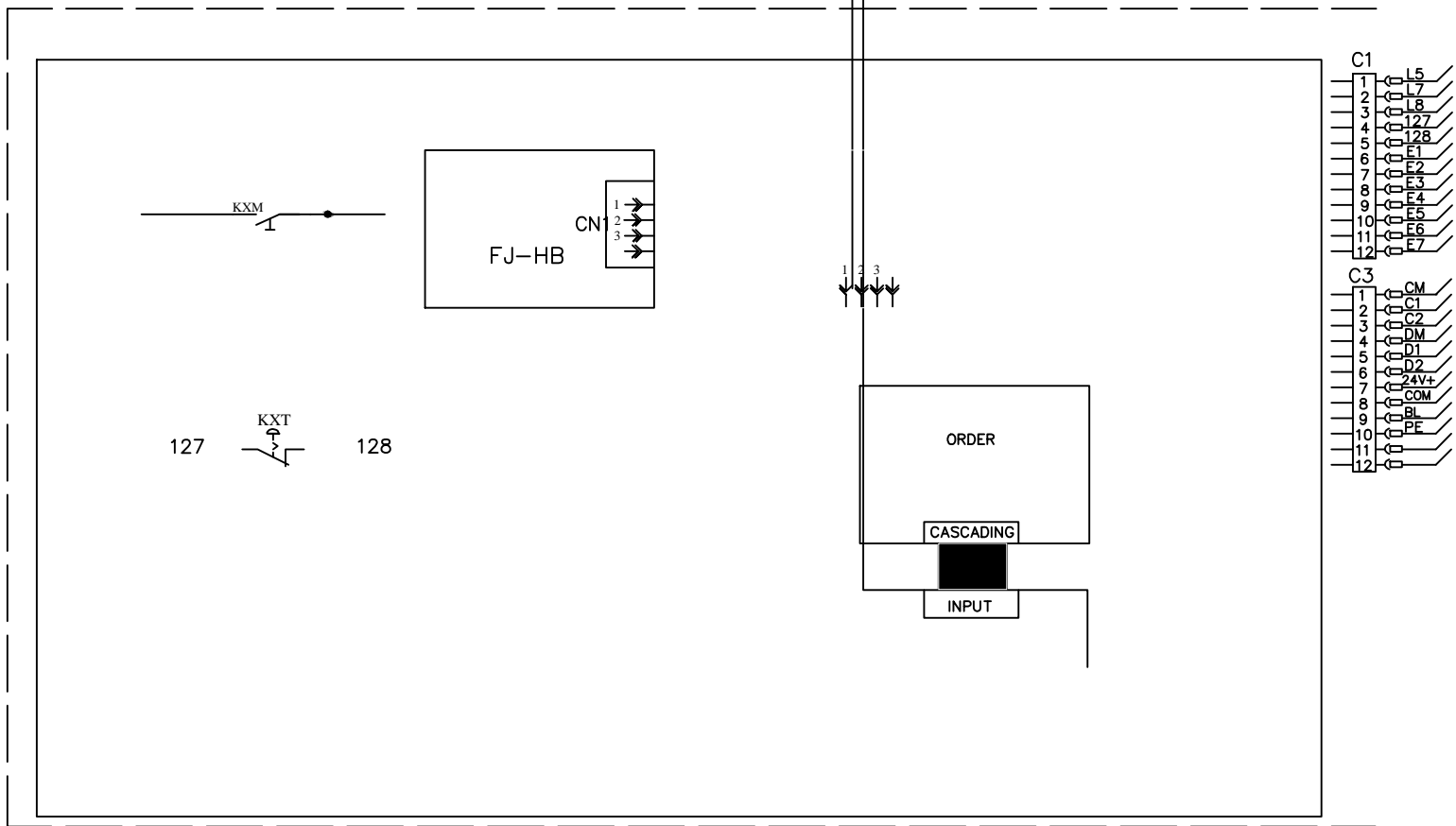

更改文件号

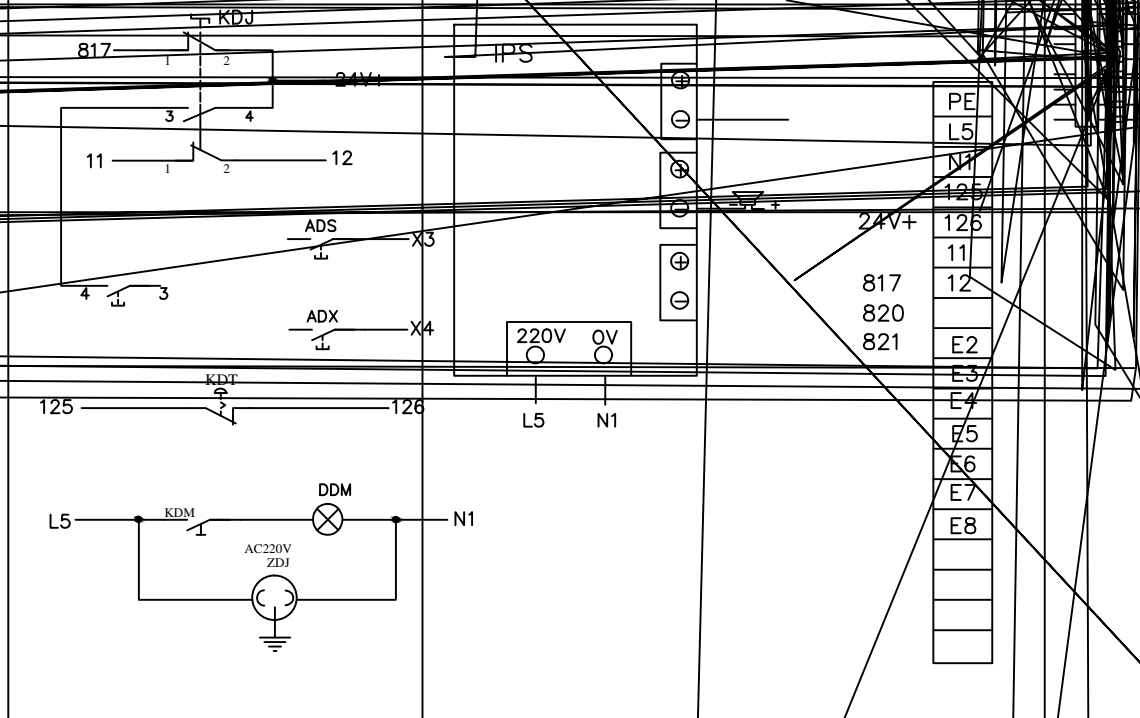

更改文件号

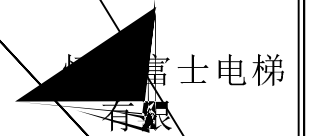

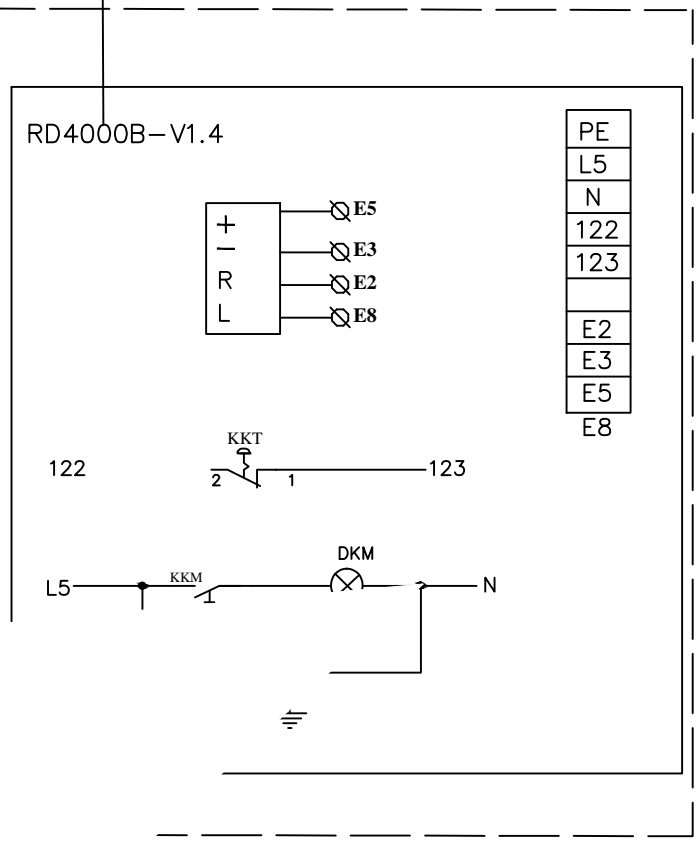
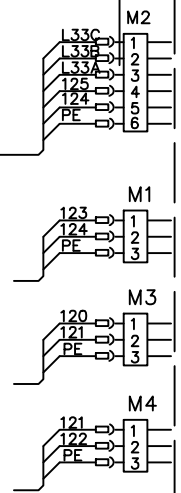
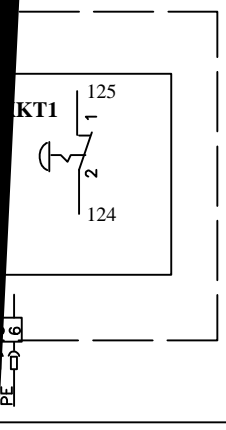

梯

有

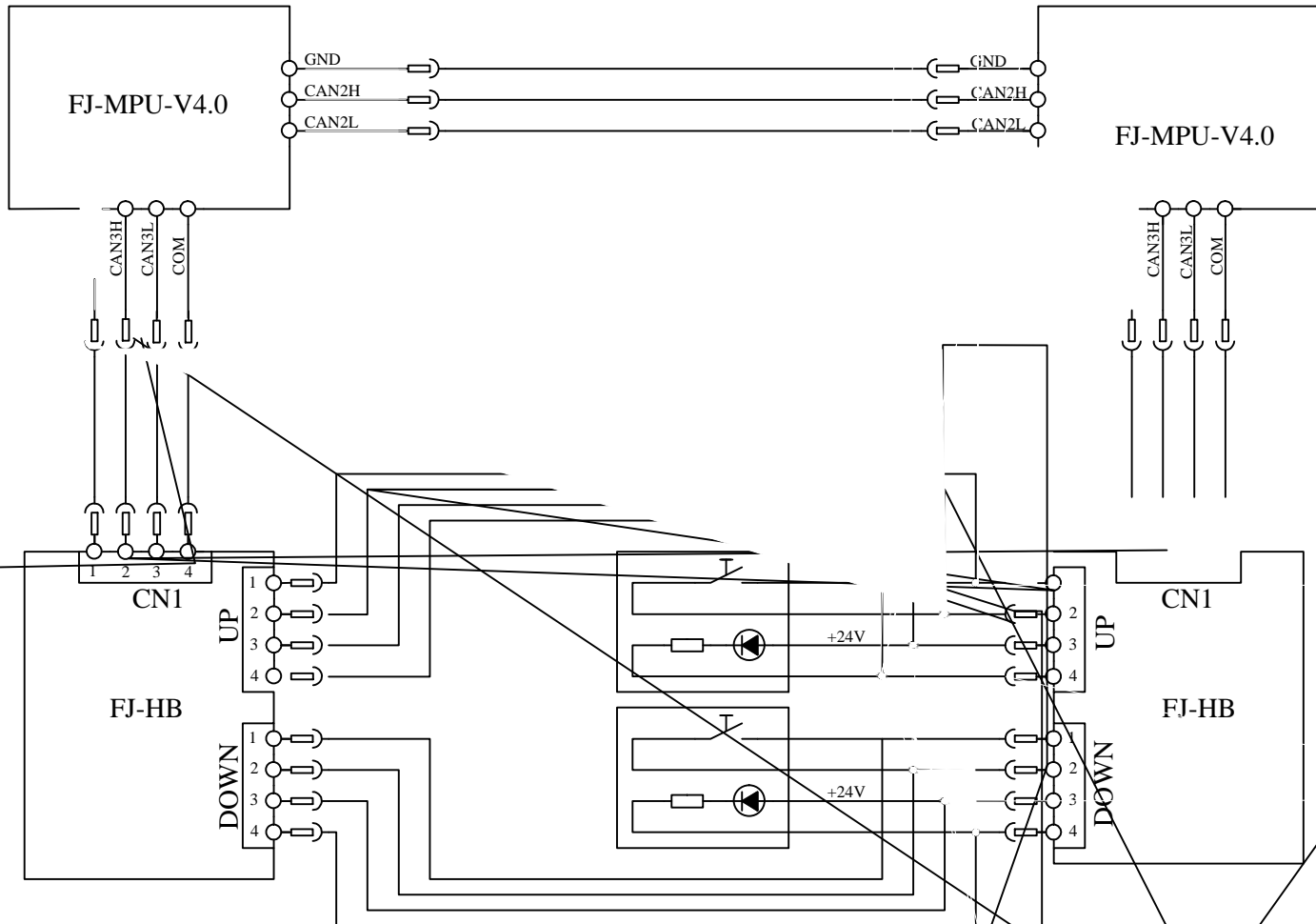

更改文件号

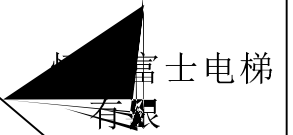

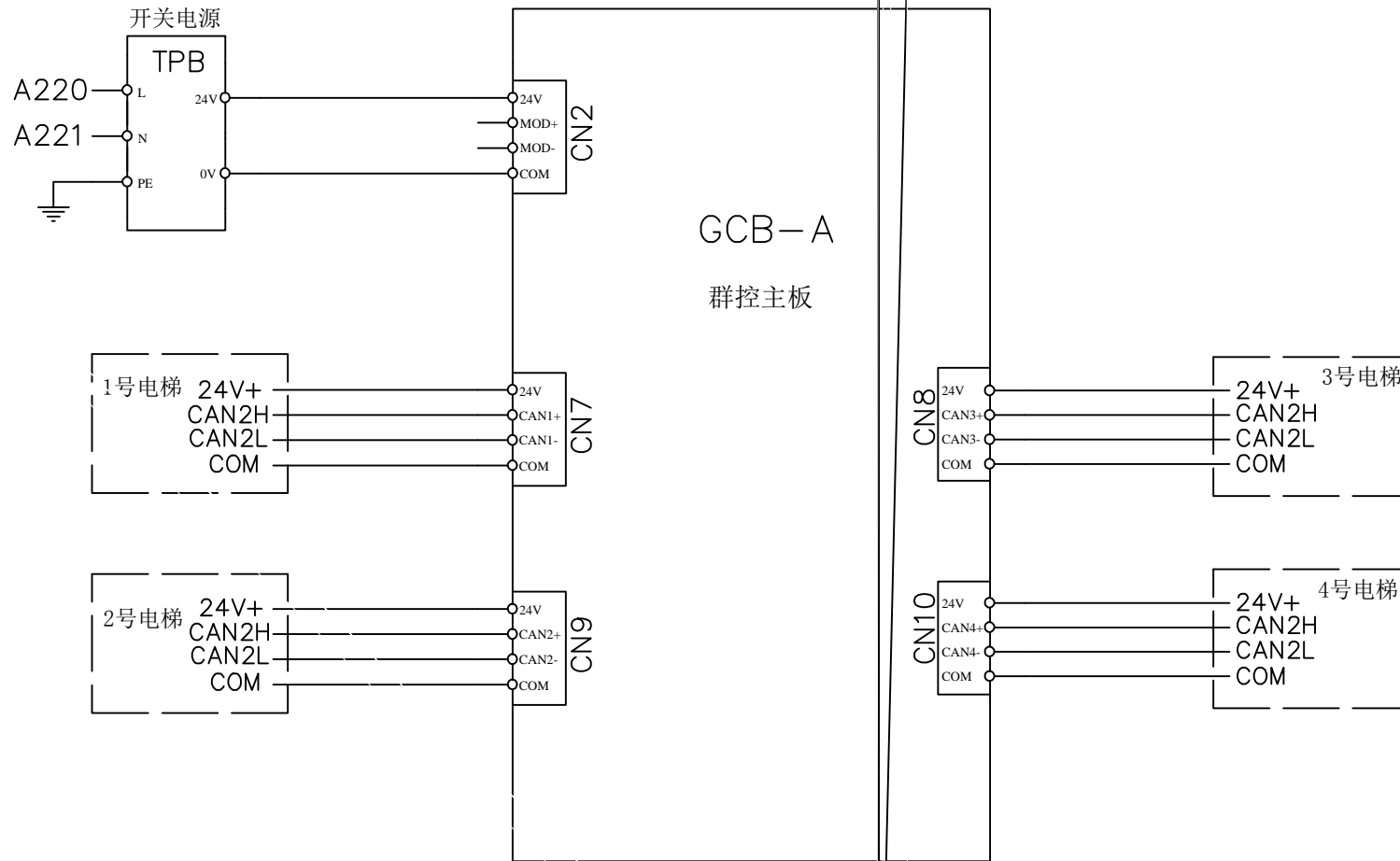

						群控板-4			恒达富士电梯有限公司	
标记	处数	分区	更改文件号	签名	年月日	阶段标识		重量	比例	H1501000
设计	汪军		标准化	王爱敏						
校对	沈丹									
审核	吴伟国									
工艺	严红星		批准	刘万兵		共 28 张		第 26 张		

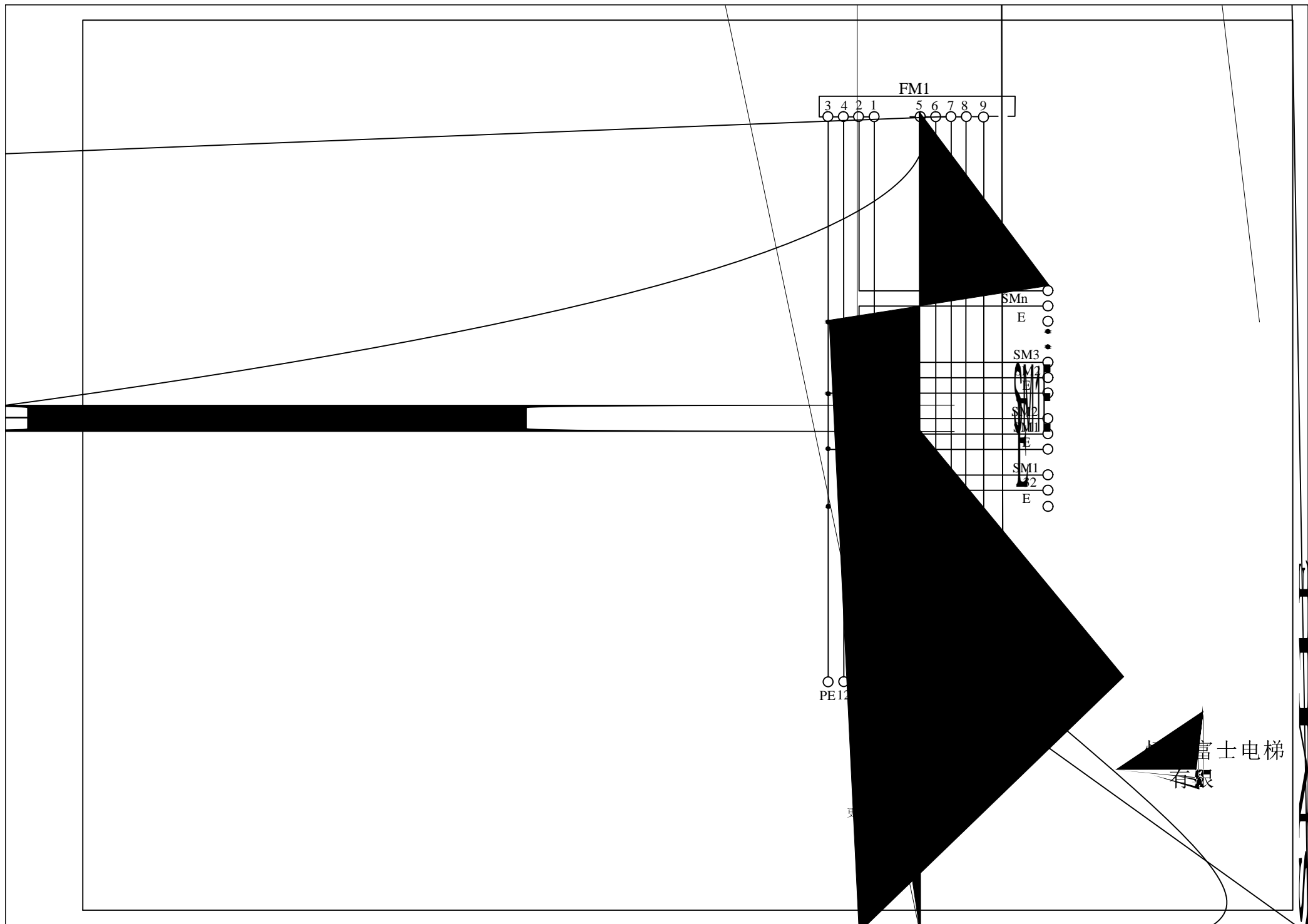

FM1

3 4 2 1 5 6 7 8 9

SMn

E

SM3

SM2

SM1

E

E

E

E

PE12

富士电梯有限公司
Fujitec Co., Ltd.

