



# Q/FJHD

企业标准信息

Q/F 1108-2022

Safety rules for the construction and installation of lifts



.....	5
.....	8
1 .....	9
2 .....	10
3 .....	11
4 .....	12
5 .....	12
5.1 .....	12
5.2 .....	14
5.3 .....	15
5.4 .....	16
5.5 ( ) .....	17
5.6 .....	17
5.7 .....	18
5.8 .....	19
5.9 .....	20
5.10 .....	20
6 .....	19
6.1 .....	19
6.2 .....	20
6.3 .....	21
6.4 .....	22
7 .....	23
7.1 .....	23
7.2 .....	24
7.3 .....	27
7.4 .....	27
7.5 .....	28
7.6 “ ” .....	29
7.7 .....	31
7.8 .....	31
8 ( ) .....	32
8.1 .....	32
8.2 .....	32
8.3 .....	33
8.4 .....	34

企业标准信息公共服务平台

2022

07

22

19

27

2022

07

22

19

27



8.5	.....	34
8.6	.....	34
8.7	.....	35
8.8	.....	36
8.9	.....	37
8.10	.....	37
8.11	.....	37
8.12	.....	37
8.13	.....	39
8.14	.....	39
8.15	.....	39
8.16	.....	39
8.17	.....	39
8.18	.....	39
9	.....	40
9.1	.....	40
9.2	.....	41
9.3	.....	41
9.4	.....	41
9.5	.....	41
9.6	.....	41
9.7	.....	42
9.8	.....	43
9.9	.....	44
9.10	.....	45
9.11	.....	48
10	.....	48
10.1	.....	49
10.2	( ) .....	49
10.3	.....	49
10.4	.....	50
10.5	.....	51
11	( ) .....	51
11.1	.....	51
11.2	.....	52
11.3	( ) .....	52
12	.....	53
12.1	.....	53



12.2	( )	53
12.3		54
12.4		54
12.5		54
12.6		54
12.7		55
12.8		56
12.9		56
12.10		56
12.11		56
13		57
13.1		57
13.2		58
13.3		58
13.4		59
13.5		60
13.6		61
14		61
14.1		65
14.2		68
15		69
15.1		69
15.2		69
15.3		69
15.4		70
15.5		70
15.6		71
15.7		71
15.8		71
15.9		71
15.10		72
15.11		72
15.12		72
15.13		72
15.14		72
15.15		72
15.16		72
16		72



16.1	.....	72
16.2	.....	73
16.3	.....	74
A	.....	76
B	.....	77
C	.....	79
D	.....	82
E	.....	83
F	.....	106
G	.....	133
H	.....	137
J	.....	143
K	.....	144
L	.....	145
M	.....	151
N	.....	155

企业标准信息网  
2022 07 22 19 27



GB/T 7588.1/2

企业标准信息

2022

07

22

19

27

GB/T 7588.1/2

2022

07

22

19

27

0

0.1

0.1.1

0.1.2

0.1.2.1

a)

b)

c)

d)

e)

f)

g)

h)

1)

2)

3)

0.1.2.2

a)

b)

c)

( )

0.1.2.3

a)

b)

c)

0.2

0.2.1



0.2.3

( )

a)

b)

(

)

c)

0.2.4

0.2.5

a)

b)

c)

d)

0.3

0.3.1

a)

b)

c)

d)

0.3.2

0.3.3

0.3.4

0

100

0.3.5

0.3.6

0.3.7

( )

0.3.8

0.3.9

a)

300 N



b)

1000N

0.3.10



1

2

企业标准信息

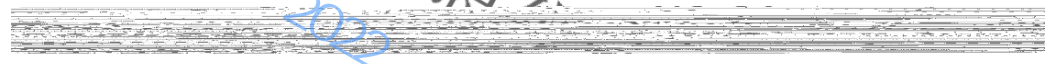

GB/T 786.1

1

GB/T 786.1 2009 ISO 1219-1:2006 IDT

GB/T 3639

GB 4053.1

1

GB 4053.2

2

GB/T 4208 (IP ) GB/T 4208 2017 IEC 60529:2013

IDT

GB/T 4728

IEC 60617 database

GB/T 5013.5 450/750V

5

GB/T 5013.5 2008

IEC 60245-5:1994 IDT

GB/T 5023.6 450/750V

6

GB/T 5023.6 2006 IEC 60227-6:2001 IDT

GB/T 5226.1 2019

1

IEC 60204-1:2016

IDT

GB/T 5465.2 2008

2

IEC 60417

DB 2007 IDT

GB/T 7588.2 2020

2

ISO

8100-2:2019 MD

GB 8624

GB/T 8903 GB/T 8903 2018 ISO 4344:2004 MD



GB/T 12668.502 2013 5-2 IEC  
 61800-5-2:2007  
 IDT  
 GB/T 13793  
 GB/T 14048.4 2010 4-1  
 IEC 60947-4-1:2009 Ed.3.0 MOD  
 GB/T 14048.5 2017 5-1  

---

 IEC 60947-5-1:2016 MOD  
 GB/T 14048.14 5-5  
 GB/T 14048.14 2019 IEC 60947-5-5:2016 IDT  
 ISO  
 GB/T 15706 2012  
 12100:2010 IDT  
 GB/T 16895.2 2017 4-42 IEC  
 60364-4-42:2010  
 IDT  
 GB/T 16895.21 2011 4-41 : IEC  
 60364-4-41:2005  
 IDT  
 GB/T 16895.23 2012 6 IEC 60364-6:2006  
 IDT  
 GB/T 16935.1 1 GB/T  
 16935.1 2008  
 IEC 60664-1:2007 IDT  
 GB/T 17889.2 2012 2  
 GB/T 18209.3 2/3  
 GB/T  
 18209.3 2010 IEC 61310-3:2007 IDT  
 GB/T 18775  
 GB/T 21711.1 1 GB/T 21711.1  
 2008 IEC  
 61810-1:2003 IDT  
 GB/T 23821 2009 ISO  
 13857:2008 IDT  
 GB/T 24475



GB/T 24476 2017

GB/T 24480

GB/T 24807

GB/T 24808

GB/T 27903

GB/T 32957

GB 50017

GA 494

JB/T 8734.6

450/750V

6

IEC 61810-3

[Electromechanical elementary relays - Part 3: Relays with forcibly guided (mechanically linked) contacts]

EN 50274

Low voltage switchgear and control gear assemblies - Protection against electric shock -

Protection against unintentional direct contact with hazardous live parts

3

GB/T 7024

3.1 traction drive lift

3.2 ( ) positive drive lift

3.3 non-commercial vehicle lift

3.4 pulley room

3.5 available car area

1m

3.6 re-leveling

( )



3.7 minimum breaking load of a rope  
(mm<sup>2</sup>) (N/mm<sup>2</sup>)

3.8 safety rope  
( )

3.9 user

3.10 passenger

3.11 authorized and instructed user

a)

b)

3.12 lift machine

3.13 balancing weight

3.14 electric safety chain

3.15 inspection trap

3.16 emergency door to the well  
11m

3.17 laminated glass

3.18 unintended car movement

4

4.1

(SI)

4.2

5

5.1

5.1.1

5.1.2

( )

( )

5.2

5.2.1

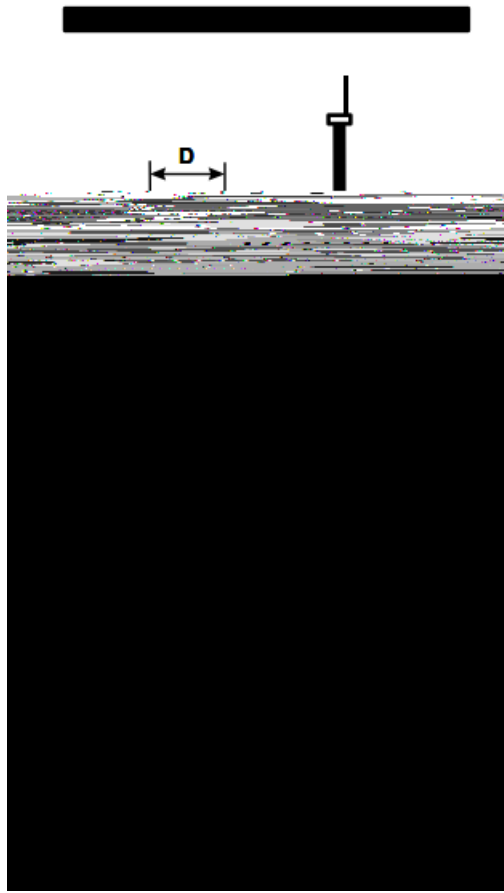

C

H

D







1

5.3

企业标准信息

5.3.1

5.3.1.1

300N

5cm<sup>2</sup>

a)

b)

15mm

5.3.1.2

5.2.1.2

5.3.2

5.3.2.1

(N) [ G( )G2.3 G2.4]

5.3.2.2

4g<sub>n</sub>(P+Q)

P—

)

kg

Q—

kg

g<sub>n</sub>—

9.81 m/s<sup>2</sup>

5.3.2.3

( ) 4

4g<sub>n</sub>(P+qQ)

4g<sub>n</sub>qP

:

q—

5.3.3

6.3.1 ( )6.4.1  
G5.1

5.4

5.4.1

5.4.2



5.4.3

a) 50mm, 25mm 1/2

b) 5cm<sup>2</sup> 300N

1) 10mm 5mm 2mm

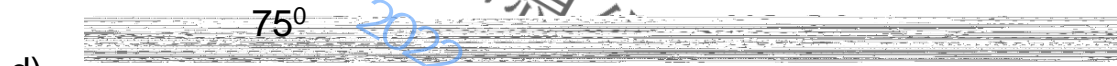

d) 1) 2) 600

20mm ( )

( )

5000N/m<sup>2</sup>

a) ( )

b) ( )

5.6

5.6.1 ( ) 0.30m 2.50m

( ) 0.10m GB I2265.1—1997 4.5.1

5.6.2

5.6.2.1 ( ) GB I2265.1—1997 4.5.1

2.50m

5.6.2.2 [ 5.2.2.2 ( ) ]

0.50m

0.10m



5.7

5.7.1

K( )

5.7.1.1

a)  $0.1+0.035 v^2(m)$

注：0.035  $v^2$ 表示对应于15%额定速度  $v$  时的重力制停距离的一半。即  $\frac{1}{2} \times \frac{(1.15v)^2}{2g_H} = 0.0337 v^2$ ,

圆整为0.035  $v^2$ 。

b) ~~8.13.2 [ 5.7.1.1c]~~

)  $1.0+0.035 v^2(m)$

c) 1) [ 2]

2)  $0.3+0.035 v^2(m)$

3)  $0.1+0.035 v^2(m)$

d)  $0.50m \times 0.60m \times 0.80m$

( )

0.15 m

5.7.1.2

$0.1+0.035 v^2(m)$

5.7.1.3

12.8

5.7.1.1

5.7.1.2  $0.035 v^2$

a)  $4m/s$   $1/2$  0.25m

b)  $4m/s$   $1/3$  0.28m

5.7.1.4 ( )

$0.035 v^2$  ( )  
 $1/500$  0.20m

5.7.2

5.7.2.1

0.50m

5.7.2.2

a)  $8.13.2$  [ 5.7.2.2b)

] ( )  
1m

b)



1) ] 0.30 m [ 2]

2) 0.10m

c) 0.50m×0.60m×0.80m (

) 0.15 m

5.7.2.3 ( )  
0.30 m

5.7.3

5.7.3.1

5.7.3.2 2.50m 5.2.2

5.7.3.3

a)

0.50m×0.60m×1.0m

b)

0.15m

0.50m

0.10m

1)

2)

c)

0.30m

b)1) b)2)

5.7.3.4

a)

14.2.2 15.7

b)

( 13.6.2)

c)

( 5.9)

5.8



5.2.1.2

a)

b)

1.50m

( 5.2.1.2)

5.9

1m

50 lx

0.50m

5.2.1.2

5.10

14.2.3.2

14.2.3.3

6

6.1

6.1.1

( )

(

a)

b)

c)

6.1.2

( )

6.1.3

a)

b)

6.2

6.2.1

a)

b)

6.2.2

- a) 4m
- b)
- c) 1.50m 650 750
- d) 0.35m 25mm 1500N  
0.15m

- e)
- f) 1.50m

- 6.3
- 6.3.1
- 6.3.1.1
- 6.3.1.2
- 6.3.2
- 6.3.2.1

- a) 2m
- 1) 0.70m
- 2) 0.50m
- b) 0.50m×0.60m  
1.80m
- ( 12.5.1)
- 6.3.2.2 0.50m
- 6.3.2.1 0.40m

- a)
- b) 0.30m
- 6.3.2.3
- 6.3.2.4 0.50m



6.3.3.2

0.80m×0.80m

0.20m×0.2m

1000N

(

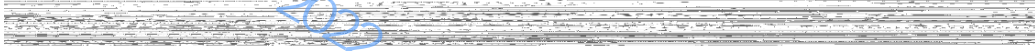

企业标准信息

2022

07 22

19 27

2022

07 22

19 27



6.4.2.2.2

6.3.2.1 6.3.2.2

6.4.3

6.4.3.1

0.60m

1.40m

6.4.3.2

0.80m×0.80m

0.20m×0.20m 1000N

6.4.3.3

( )

6.4.4

50mm

6.4.5

14.2.2 15.4.4

6.4.6

6.4.7

100 lx

13.6.1

13.6.2

6.3.6

7

7.1

6mm

8mm

10mm



## 7.2

### 7.2.1

### 7.2.2

GA 109

### 7.2.3

#### 7.2.3.1

a 300 N

	5 cm <sup>2</sup>	
1		1 mm
2		15 mm

b 1000 N

100 cm<sup>2</sup>

[ 7.1 10 mm 7.7.3.1]

a b

#### 7.2.3.2

)

7.1

150N ( 6mm

a) 30mm

b) 45mm

#### 7.2.3.3

/

#### 7.2.3.4

#### 7.2.3.5

a)

b)

c) [ (8+0.76+8)mm]

#### 7.2.3.6

7.6.2

a)

b) 1.10m

c)

d)

#### 7.2.3.7

7 /



7.2.3.8

150 mm

a

J

7

1

2

0.12 m

3

4

b

J 19

7

7.6.2 a

1

2

2 mm

企业标准信息

2022

07

22

19

27

2022

07

22

19

27



## 7

	800 nm	800 nm	500 nm	500 nm
	1.0 ± 0.1 m		1.0 ± 0.1 m	
[ 7a ]				
[ 7b ]	×	×		×
[ 7c ]	×	×		×
[ 7d ]	×		×	
1 m [ 7e ]	×	×		×
1 m [ 7f ]	×		×	
150 nm [ 7g ]	×			
7.6 2	×	×		
×				

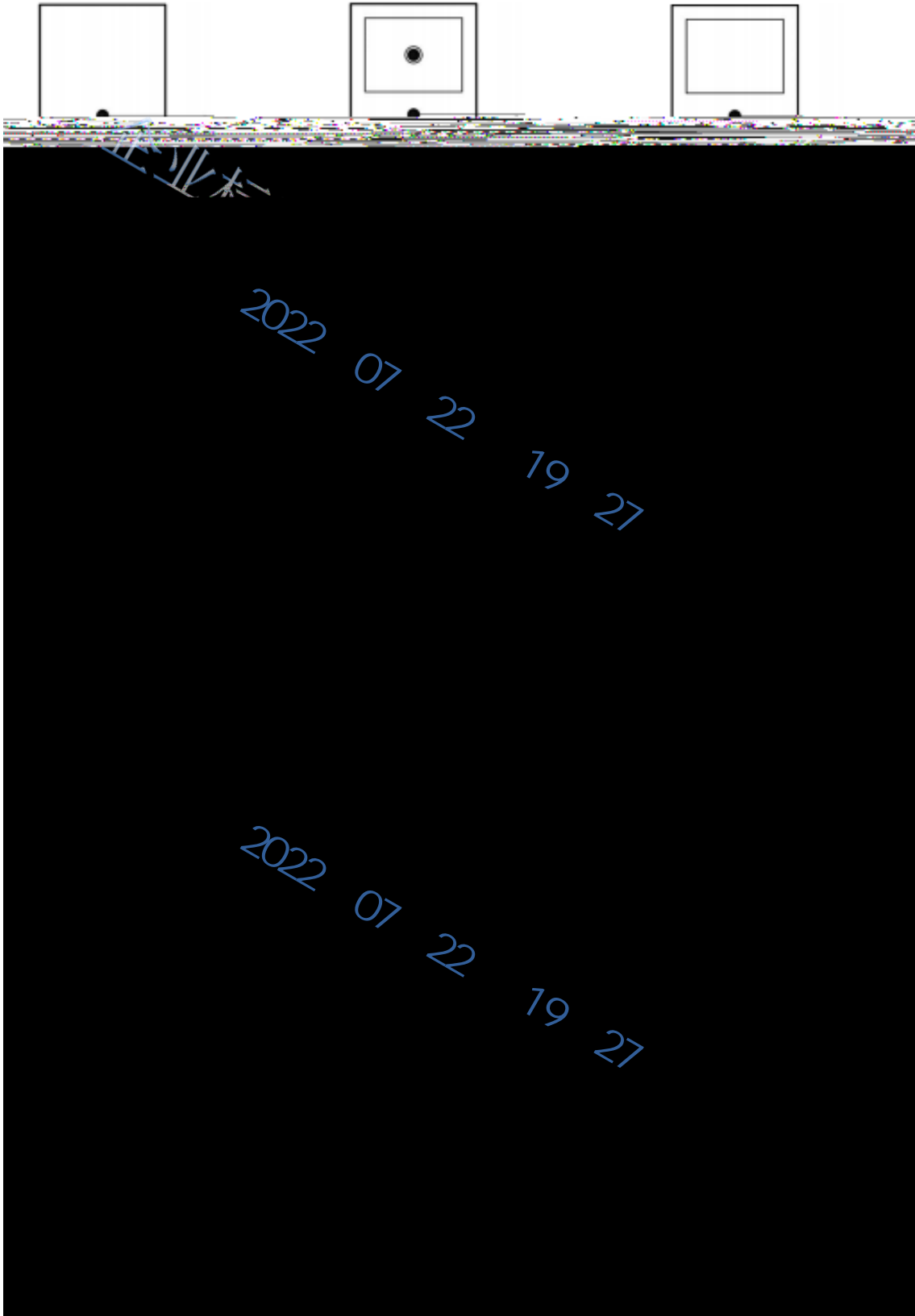

2

1.00 m

± 0.10m



g)

[ 7a 7b) ]

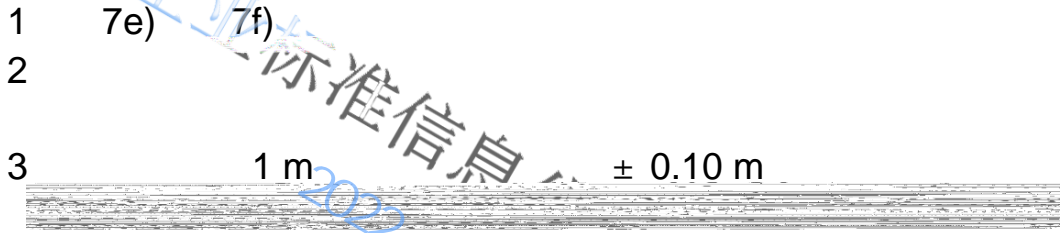

7

7.3

7.3.1

2m

7.3.2

50mm

7.4

7.4.1

7.4.2

7.4.2.1

7.4.2.2

7.4.2.3

7.4.3

7.4.3.1

7.4.3.2

7.4.3.3

7.4.3.4

**7.5**

7.5.1

25

8



3mm

B( )

7.5.2

7.5.2.1

7.5.2.1.1

7.5.2.1.1.1

150N

1/3

7.5.2.1.1.2

10J

a)

25mm

b)

50mm

25N/mm

7.5.2.1.1.3

( 8.7.2.1.1.3)

50mm

7.5.2.1.1.2

4J

7.5.2.1.1.4

7.5.2.1.1.1

7.5.2.1.1.2

7.5.2.1.1.5

150N

( )

100mm

7.5.2.1.2

)

7.5.2.1.1.2

10J

0.3m/s

7.5.2.2



a)

b)

0.3 m/s

c)

8.6.1

2/3

d)

7.5.2.3

7.6

“ ”

7.6.1

50 1x

( 0.2.5)

7.6.2 “ ”

a) b)

a)

7.2.3.1

1)

2)

6mm

3)

0.015m<sup>2</sup>

0.01m<sup>2</sup>

4)

60mm

150mm

80mm

1m

b)

“ ”

7.7

7.7.1

( )

0.2m

0.35m

7.7.2

7.7.2.1

7.7.2.2

7.7.2.2



a) 14.2.1.2

b) 8.4.3, 8.14 14.2.1.5

1.65m

1)

2 m

2)

7.7.3

7.7.1

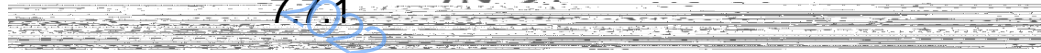

7.7.3.1

14.1.2

7.7.3.1.1

7mm

3

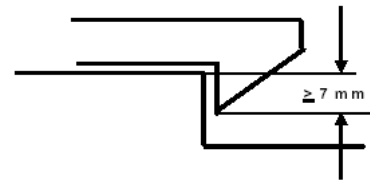
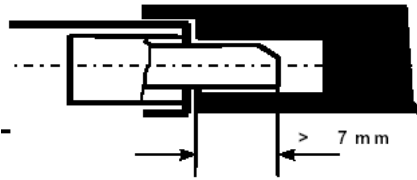

3

7.7.3.1.2

7.7.3.1.3

7.7.3.1.4

7.7.3.1.5

300N

7.7.3.1.6

F( )FI

a)

1000N

b)

3000N

7.7.3.1.7





( )

(

)

7.7.3.1.8

7.7.3.1.9

7.7.3.1.10

7.7.3.2

B

( )

7.7.3.3

F1

7.7.4

7.7.4.1

14.1.2

7.7.2

7.7.4.2

7.7.4.3

7.7.5

7.7.5.1

7.7.5.2

7.7.6

7.7.6.1

a)7.7.4.1 7.7.4.2

b)

7.7.6.2

( )

14.1.2



7.8

8

8.1

8.1.1

8.1.2

8.2

8.2.1

( )  
企业标准信息

2m

2m

2022 07 22

1

19

1m

27

1

5

14.2.5

1

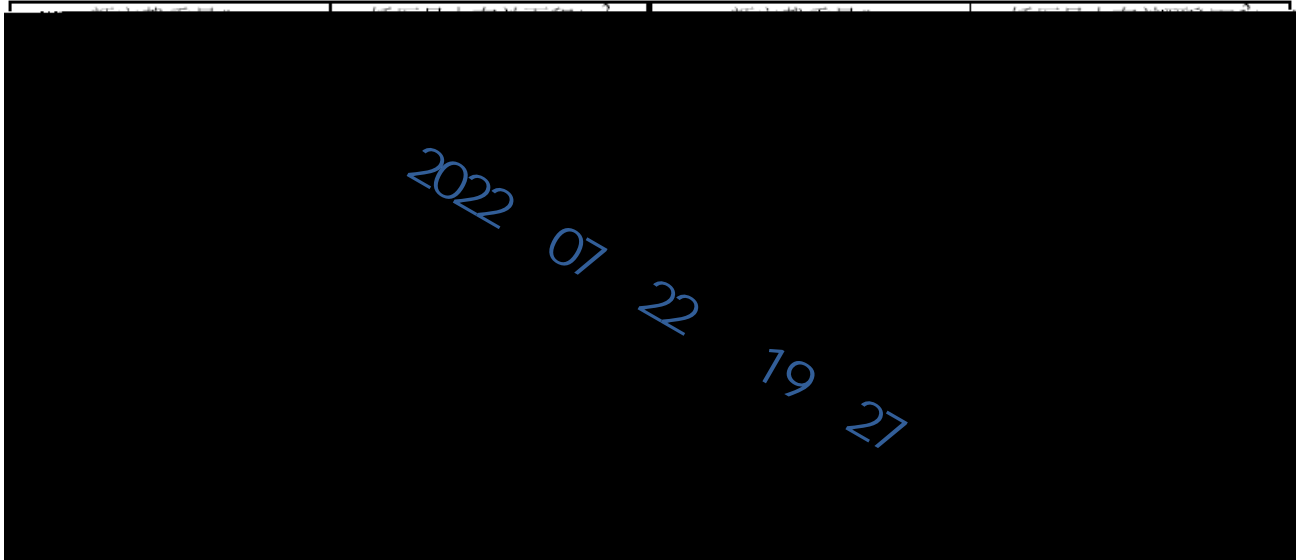

2022 07 22 19 27

8.2.2

1

1

1

“ ”

a)

1



(  
)

b) 14.2.5

c) ( 15.5.3)

d)

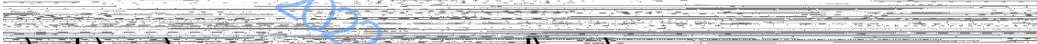
e) 

a) b) c) d) e)

D( )D2h)

D2j)

D2l)

200kg/m<sup>2</sup>

8.2.3

a) 75/

b) 2

2

乘客人数/人	轿厢最小有效面积/m <sup>2</sup>	乘客人数/人	轿厢最小有效面积/m <sup>2</sup>

8.3

8.3.1

a)

b)

c)

8.3.2



8.3.2.1

300N

5cm<sup>2</sup>

a)

b)

15mm

8.3.2.2

J1

J

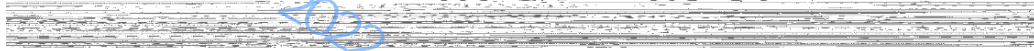

1.10m

0.90m 1.10m

8.3.2.3

8.3.2.4

a)

b)

c) [ (8+0.76+8)mm]

8.3.2.5

8.13

8.3.3

8.4

8.4.1

60°

8.4.2

8.4.3

20mm

0.75 m

( 14.2.1.5)

0.10m

8.5

8.6

8.6.1

10mm

60mm

8.6.2

8.6.3

6mm



8mm

10mm

8.6.1

8.6.4

8.6.5

[ 7.6.2a)]

7.6.2a)

8.6.6

7.4

8.6.7

8.6.7.1

300N

5cm<sup>2</sup>

a)

b)

15mm

c)

8.6.7.2

7.6.2

J2

J

8.6.7.3

8.6.7.4

a)

b)

c) [

(8+0.76+8)mm]

8.6.7.5

7.6.2

a)

b)

1.10m

c)

d)

8.7

8.7.1

3 mm



8.6.1

8.7.2

8.7.2.1

8.7.2.1.1

8.7.2.1.1.1

1/3

8.7.2.1.1.2

10J

150N

a)

b)

7.5.2.1.1.2 .

8.7.2.1.1.3

25mm

50mm

50mm

8.7.2.1.1.2

4J

8.7.2.1.1.4

150 N

( )

100mm

8.7.2.1.1.5

15 mm

8.7.2.1.2

)

7.5.2.1.1.2

0.3m/s

10J

8.7.2.2

a)

b)

0.3 m/s

c)

8.6.1

d)

2/3

8.8

8.9

8.9.1 7.7.2.2 ( )

8.9.2 14.1.2

8.9.1

8.9.3 [ 11.2.1c]  
( 7.7.3.1 7.7.3.3)

8.10

8.10.1

a) 8.9.2

1) ( )

2)

b) 11.2.1c)

8.10.2 ( )

8.9.2

a)

b)

8.11

8.11.1 7.7.1



8.12

8.12.1

12.5

8.12.2

0.35m×0.50m

8.12.3

0.75m(

5.2.2.1.2)

1.80m

0.35m

8.12.4

8.3.2 8.3.3

8.12.4.1

8.12.4.1.1

B

8.12.4.1.2

B

( )

( )

8.12.4.2

8.12.4.1

14.1.2

8.13

8.3

8.13.1

0.20m×0.20m

1000N

8.13.2

0.12m<sup>2</sup>

0.25m

8.13.3

0.30m

0.30m

8.13.3.1

0.10m

8.13.3.2





a) 0.85m 0.70m  
 b) 0.85m 1.10m  
 8.13.3.3 [ ( ) ]

0.10m

8.13.3.4

8.13.3.5

0.15 m

8.13.4

8.13.5

8.13.6

( )

9.7

8.14

14.2.1.5)

8.15

a) 14.2.1.3 ( )

b) 14.2.2 15.3

c) 13.6.2

8.16

8.16.1

8.16.2

1

50

8.16.3

10mm

8.17

8.17.1

50

lx

50 lx

8.17.2

8.17.3

7.8

8.17.4

1W

1h

8.17.5

8.17.4

14.2.3



8.18

12.2.1

8.18.1

( )

a)

b)

1m/s

8.18.2

( ) ( )

9.7

9

9.1

9.1.1

( )

9.1.2

a)

8mm

b)

1)

1570MPa 1770MPa

2)

1370MPa

1770MPa

c)

( )

GB 8903

9.1.3

9.1.4

9.2

9.2.1

40

9.2.2

N( )

a)

b)

16

c)

12

(N)

(N)

9.2.3

9.2.3.1

80

9.2.3.1

( )

( )



9.2.3.2

9.2.4

10

9.2.2

9.2.5

( )

80

9.3

a)

125 8.2.1 8.2.2

b)

( ) 19 27

c)

M( )

9.4

9.4.1 12.2.1b)

9.4.2

9.4.3

9.4.4

( ) 4°

9.5

9.5.1

9.5.1.1

9.5.1.2

9.5.2

9.5.3

14.1.2

9.5.4

9.6

9.6.1

a)

b)

30



- c) 9.7
- d)
- e) 14.1.2
- 9.6.2 3.5 m/s 9.6.1

企业标准信息  
2022 07 22 19

- 14.1.2
- 9.7
- 9.7.1 3

- a)
  - b)
  - c)
- 3 19

曳引轮、滑轮及链轮的位置		根据9.7.1的危险		
		a	b	c
轿厢上	轿顶上	×	×	×
	轿底下		×	×
对重或平衡重上			×	×
机房内		× <sup>2)</sup>	×	× <sup>1)</sup>
滑轮室内			×	



- 9.7.2
- GB12265.1—1997 4

- a)
- b)
- c)
- 9.8
- 9.8.1
- 9.8.1.1

9.10

9.8.1.2 5.5b)

)

( )  
( )  
( )

9.8.3.1  
)



c) 1m/s 1.5m/s  
 d)对于额定速度大于1m/s的渐进式安全钳为  $1.25v + \frac{0.25}{v}$  m/s)。

1m/s d)  
 9.9.2 9.9.1  
 9.9.3 ( ) 9.9.1

9.9.4

a)  
 b)300N

a)  
 b) M2.2.1

9.9.5  
 9.9.6  
 9.9.6.1  
 9.9.6.2

8

$\mu_{max}=0.2$   
 6mm

9.9.6.3  
 9.9.6.4 30  
 9.9.6.5 ( )  
 9.9.6.6

9.9.6.7  
 9.9.7

( F3.2.4.1)

9.9.8  
 9.9.8.1  
 9.9.8.2  
 9.9.8.3 9.9.8.2

a) ( ) 9.9.9

b)

c) ( )



9.9.9

9.9.1

9.9.10

9.9.11

9.9.11.1

14.1.2

1m/s

9.9.11.2

( 9.8.5.2)

14.1.2

14.2.1.4c)5)

9.9.11.3

14.1.2

9.9.12

F4

9.10

9.10.1

115

9.9.3

9.10.2

9.10.1

9.10.3

9.10.4

a)

b)

c)

( )

d)

( )

9.10.5

14.1.2

9.10.6

9.10.7

9.10.8

9.10.9

1g<sub>n</sub>

企业标准信息

2022 07 22 19 27



9.10.10

a) 9.9

b) 9.9.1 9.9.2 9.9.3 9.9.7 9.9.8.1 9.9.9 9.9.11.2  
9.9.4 9.9.6.1 9.9.6.2 9.9.6.5 9.9.10 9.9.11.3

9.10.11

F7

9.11

9.11.1

14.2.1.2

9.11.3 9.11.4

/

9.11.2

9.11.3

12.4.2

15

24

9.11.4

- a
- b
- c
- d
- e

--





--

企业标准信息

2022

07

22

19

27

2022

07

22

19

27



9.11.6

--

1 gn

--

9.11.7

7.7.1

14.1.2

9.11.8

14.1.2

9.11.7

9.11.9

9.11.10

9.11.11

9.11.12

9.11.13

F8

10

10.1

10.1.1

a)

( )

b)

1)

2)

3)

G2

G3

G4

( 0.2.5)

G

10.1.2

10.1.2.1

$$\sigma_{perm} = \frac{R_m}{S_t}$$

perm —

MPa

R<sub>m</sub> —

MPa

S<sub>t</sub> —

4

4

载荷情况	延伸率( $A_5$ )	安全系数
正常使用	$A_5 \geq 12\%$	2.25
	$8\% \leq A_5 < 12\%$	3.75
安全钳动作	$A_5 \geq 12\%$	1.8
	$8\% \leq A_5 < 12\%$	3.0

8  
JG/T 5072.1 (MPa) 5  
5

载荷情况	$R_m$ MPa		
	370	440	520
正常使用	165	195	230
安全钳动作	205	244	290

### 10.1.2.2 “T”

a) ( )

5mm

b) ( )

10mm

### 10.1.3

10.2 ( )

10.2.1 ( )

### 10.2.2

a) 0.4m/s

b)

10.2.3 ( )

### 10.3

#### 10.3.1



10.3.5

10.3.6

F5

10.4

L( )

10.4.1

10.4.1.1

10.4.1.1.1

115

0.135 <sup>2</sup>(m)

65mm

注:  $\frac{2 \times (1.15v)^2}{2g_n} = 0.1348v^2$ , 四舍五入到  $0.135v^2$

10.4.1.1.2

) 2.5 4

10.4.1.1.1

10.4.1.2

10.4.1.2.1

a)

115

1g<sub>n</sub>

b)2.5g<sub>n</sub>

0.04s

c)

1 m/s

d)

10.4.1.2.2

5.7.1.1

5.7.1.2

5.7.2.2

5.7.2.3

5.7.3.3

”

90

10.4.2 ( )

10.4.3

10.4.3.1

115

0.067 4 <sup>2</sup>(m)

10.4.3.2

12.8

10.4.3.1

( )

a)

4m/s

10.4.3.1

50

0.42m

b)

4m/s

10.4.3.1

1/3

0.54 m

10.4.3.3

a)

115

1g<sub>n</sub>

b)2.5 g<sub>n</sub>

0.04s

c)

10.4.3.4



14.1.2

10.4.3.5

10.5

10.5.1

企业标准信息

10.5.2

10.5.2.1

10.5.2.2

a)

b)

c)

10.5.2.3

a)

b)

14.1.2

10.5.3

10.5.3.1

a)

12.4.2.3.2

b)

1) a)

2)

14.1.2

12.4.2.3.1

12.7.1

13.2.1.1

c)

10.5.3.2

11

( )

11.1

11.2

4 5

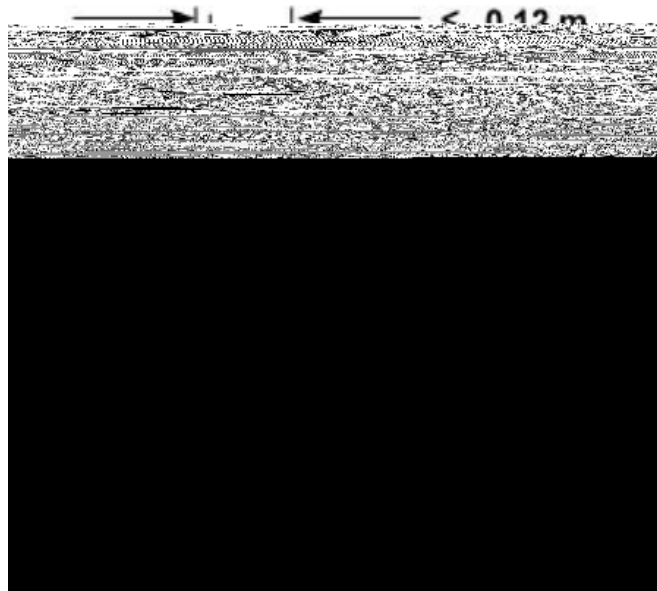

4

11.2.1

0.15 m

a)

0.20m

0.50m

b)

0.20m

c)

7.7.2.2

14.1.2

11.2.2

35mm

11.2.3



12

12.1

12.2

12.2.1

a)

b)

1)

2)

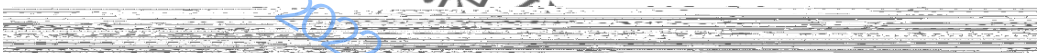

0.63m/s

12.2.2

( 12.4.1.2)

12.3

9.7

12.4

12.4.1

12.4.1.1

a)

b)

12.4.1.2

12.4.2

12.4.2.1

12.4.2.2

12.4.2.3

12.4.2.3.1



12.4.2.3.2

12.4.2.3.3

12.4.2.4 ( 12.5.1)

12.4.2.5

12.4.2.6

12.4.2.7

12.5

12.5.1

400N

12.5.1.1

14.1.2

12.5.1.2

12.5.2

12.5.1

400N

14.2.1.4

12.6

( 92 )

105

105

a) [14.2.1.2b)]

b) [14.2.1.2c)]

c) [14.2.1.3d)]

d) [14.2.1.4e)]

e) [14.2.1.5c)]

12.7

14.1.2

12.7.1

企业标准信息公共服务平台  
2022 07 22 19 27



12.7.2  
12.7.2.1

—

- a)
- b)
- c)

b) c)  
( )  
12.7.2.2

- a) 12.7.2.1
- b)
- 1)

- 2)
- 3)

)  
12.7.3

a)

b)  
1) ( )

- 2)
- 3)

(



12.7.4 12.7.2.2b)2) 12.7.3b)2) 12.7.2.2b)3)

12.7.3b)3) 14.1.2.3

14.1.1 12.7.3a)

12.8

12.8.1 10.4.3.2

12.8.2

12.8.3

12.8.4

a)

b)

c)

14.1.2

12.8.5

14.1.2

12.9

14.1.2

9.5.3

12.10

12.10.1

a)

b)

12.10.2

a)45s

b) 10s 10s

20s

12.10.3

12.10.4

**12.11**



- a)
- b)
- c)
- d)
- e)

9.7

12.12

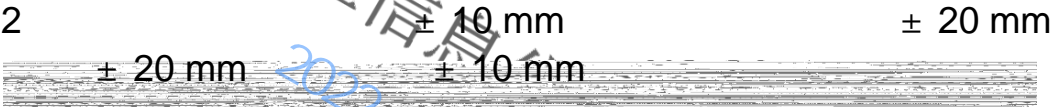

13

- 13.1
- 13.1.1
- 13.1.1.1

- a)
- b)

13.1.1.2

13.1.1.1

13.1.1.3

EN 12015 EN 12016

13.1.2

IP2X

13.1.3

(HD384.6.61S1)

6

6

$V$	( ) $V$	$/M$
500	250	0.25
500	500	0.50
500	1000	1.00

13.1.4



250V

13.1.5

13.2

13.2.1

13.2.1.1

GB 14048.4

a)AC-3

b)DC-3

12.7

)

10

13.2.1.2

GBI4048.5

a)AC-15

b)DC-13

13.2.1.3

13.2.1.1

13.2.1.2

a) b)

13.1.1.1

a)

( )

b)

( )

13.2.2

13.2.2.1

13.2.1.2

13.2.1.3

13.2.2.2

14.1.1.1f)

13.2.2.3

( )

14.1.2.2.3

( )

13.2.1.1

13.2.1.2

13.2.2.1

GB I4048.4

GB I4048.5

H(

) H1(3.6)

13.3

13.3.1

13.3.2

(13.3.3

)

13.3.3

13.3.6

13.3.4

13.3.2

13.3.3

13.3.5



13.3.6

13.4

13.4.1

a)

b)

c)

d)

e)

f)

13.4.2 13.4.1

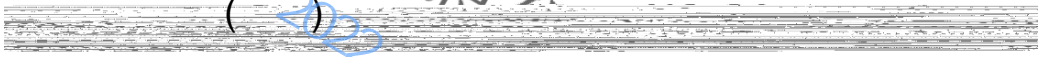

14.1.2

13.4.3

13.4.4

13.5

13.5.1

13.1.1.2

GB 5023.3 GB

5013.4

13.5.1.1	GB 5023.3—1997	2	[227IEC01(BV)]	3
[227IEC02(RV)]	4 [227IEC05(BV)]	5	[227IEC06(RV)]	
	( )			



GB 5023.1—1997 A

13.5.1.2

GB 5023.4—1997 2

( )

13.5.1.3

GB 5013.4—1997 3

[245IEC53(YZ)]

GB

5023.5—1997 5

[227IEC52(RVV)]

GB 5013.4—1997 5

[245IEC66(YCW)]

13.5.1.2

(

)

GB 5023.6

GB 5013.5

13.5.1.4

13.5.1.1

13.5.1.2

13.5.1.3

a)

1)

100VA

2) ( )

( )

50V

b)

1)

2)

13.5.2

0.75mm<sup>2</sup>

13.5.3

13.5.3.1

13.5.3.2 13.1.2

13.5.3.3

50V

13.5.3.4

13.5.3.5

13.5.3.6



13.5.4

13.6

13.6.1

13.4

13.6.2

13.6.1

a) 2P+PE 250V

b) GBI4821.1

13.6.3

13.6.3.1

13.6.3.2

( )

13.6.3.3 13.6.3.1 13.6.3.2

14

14.1

14.1.1

14.1.1.1

14.1.1.2 ( )

H

14.1.2.3

14.1.1.1

a)

b)

c) ( )

d)

e)



f)

g)

h)

i)

j)

14.1.1.2

14.1.2.2

14.1.1.3

a)

b)

14.1.2

14.1.2.1

14.1.2.1.1

A( )

14.1.2.4

a)

14.1.2.2

12.7

b)

14.1.2.3

1)

14.1.2.2

12.7

2)

14.1.2.2

3)

H

14.1.2.1.2 ( )

14.1.2.1.3

( 14.2.1.2 14.2.1.4 14.2.1.5)

14.1.2.3

14.1.2.1.4

14.1.2.1.5

14.1.2.1.6

14.1.2.1.7





14.1.2.1.8

14.1.2.2

14.1.2.2.1

企业标准信息

14.1.2.2.2  
250V

IP4X  
IP4X

500 V

GBI4048.5

a)AC—15

b)DC—13

14.1.2.2.3

IP4X

3mm,

4mm

4mm

IP4X

3mm

14.1.2.2.4

2

mm

14.1.2.2.5

14.1.2.3

14.1.2.3.1

14.1.2.3.2

14.1.2.3.2.1

14.1.1

6

( )

( )

故障 1

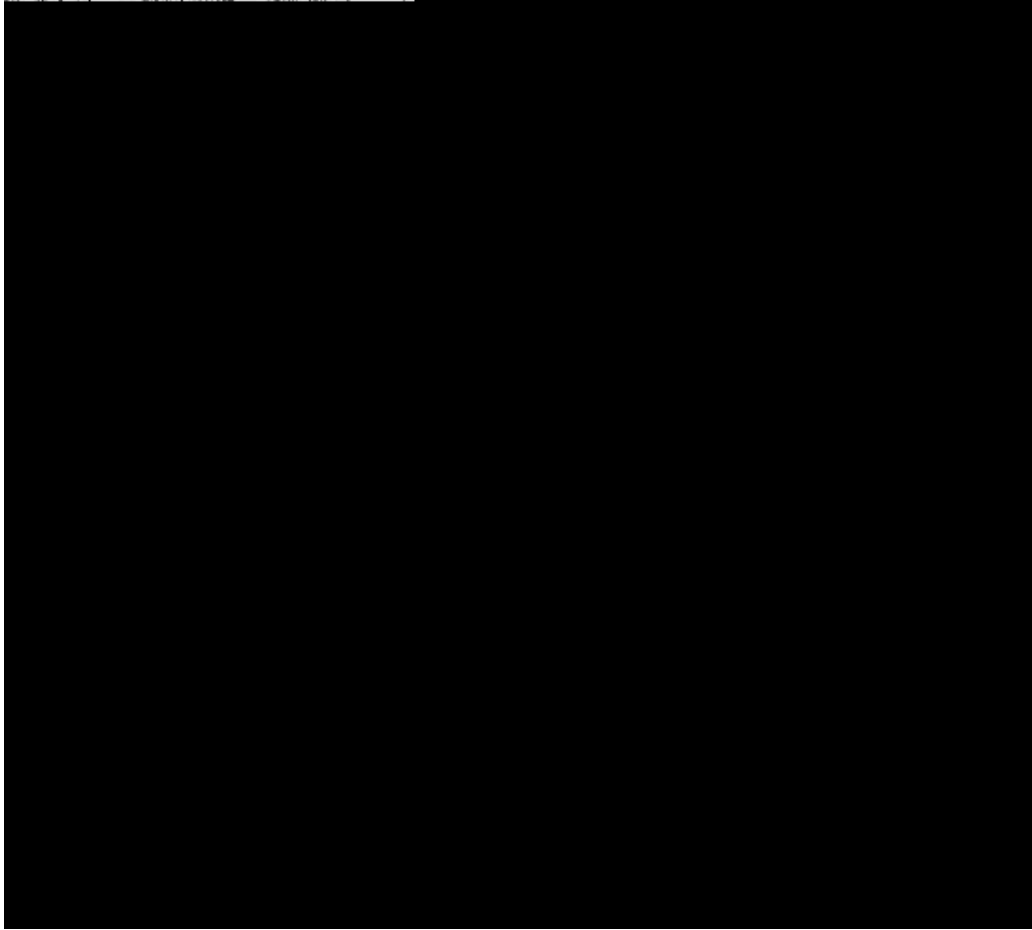

6

14.1.2.3.2.2



14.1.2.3.2.4

14.1.2.3.2.1

14.1.2.3.2.3

14.1.2.3.2.5

14.1.2.3.3

F6

14.1.2.4

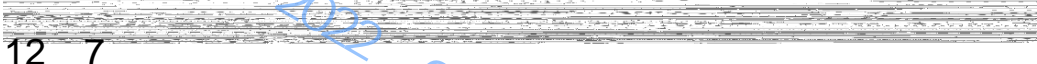

12 7

14.1.2.5

F6.3.1.1

14.2

14.2.1

14.2.1.1

14.2.1.2

7.7.2.2a)

a) ( 7.7.1)

1)

2) 14.1.2.2

14.1.2.3

3)



14.1.2

4)

b)

1)

2)

c)

0.8m/s

0.8m/s

0.3 m/s

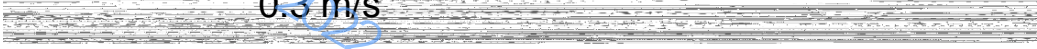

企业标准信息

07 22 19 27

2022 07 22 19 27



a)

b)

c)

14.1.2

1)9.8.8

2)9.9.11.1 9.9.11.2

3)9.10.5

4)10.5

5)10.4.3.4

d)

e)

0.63m/s

14.2.1.5

7.7.2.2b)

a)

1.65 m

b)

14.1.2

c)

0.3 m/s

d)

e)

f)



i) 114.2.2.1e]

14.2.2

14.2.2.1

a) [5.7.3.4a)]

b) (6.4.5)

c) (8.15)

1 m

1 m

d) [14.2.1.3c)]

e) [14.2.1.5i)]

1 m

( 15.2.3.1)

14.2.2.2

14.1.2

14.2.2.3

14.2.3

14.2.3.1

14.2.3.2

8.17.4

14.2.3.2

14.2.3.3

14.2.3.4

2022 07 22 19 27 30m

8.17.4

14.2.4

14.2.4.1

2 s

14.2.4.2

2 s

14.2.4.3

14.2.5

14.2.5.1

14.2.5.2

10

75 kg



14.2.5.3

- a) ( )
- b)
- c)
- d) 7.7.2.1 7.7.3.1

15

15.1

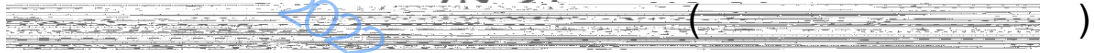

( )

15.2

15.2.1

8.2.3

“.....kg.....”

a)10mm

b)7 mm

15.2.2

15.2.3

15.2.3.1

( )

“ ”

( )



“ ”

15.2.3.2

a)

2 1 0 1 2 3

b)



15.2.4

a)

b)



c)

15.3

a)

b)

c)

d)

15.4

15.4.1

“

——”

“

——

”

15.4.2

( )

15.4.3

15.4.3.1

15.4.3.2

15.4.4

“ ”

15.4.5

( 6.3.7)

15.5

15.5.1

“

——

”

15.5.2

“ ”

15.5.3

企业标准信息

2022 07 22 19 27

2022 07 22 19 27



15.6

a)

b)

c)

15.7



15.16

- a)
- b)
- c)

15.17

F8.1

- a
- b
- c

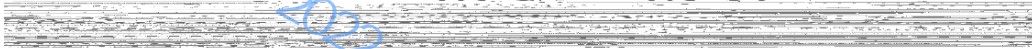

16

16.1

16.1.1

C( )

16.1.2

D

C

16.1.3

- a)
- b)
- c)
- d)
- e)
- f)
- g)
- h)

( )

A A1

9.11.7	
9.11.8	



## 16.2

a)

1)

2)

3)

( )

4)

( 16.1.3)

5)

6)

( GB/T 4728 )

b)

1)

[ E( ) ]

2)

3)

## 16.3

### 16.3.1

a)

b)

c)

G .



16.3.3.1

E

16.3.3.2

E

企业标准信息

2022 07 22 19 27

2022 07 22 19 27



A

( )

A1

A1

A1

5.2.2.2.2

5.7.3.4a)

6.4.5

7.7.3.1

7.7.4.1

7.7.6.2

8.9.2

8.12.4.2

8.15b)

9.5.3

)

9.6.1e)

9.6.2

9.8.8

9.9.11.1

9.9.11.2

9.9.11.3

9.10.5

10.4.3.4

10.5.2.3b)

10.5.3.1b)2)

11.2.1c)

12.5.1.1

12.8.4c)

12.8.5

12.9

13.4.2

14.2.1.2a)2)



14.2.1.2a)3)

( )

14.2.1.3c)

14.2.1.5b)

14.2.1.5i)

企业标准信息

2022

07

22

19

27

2022

07

22

19

27



**B**

( )

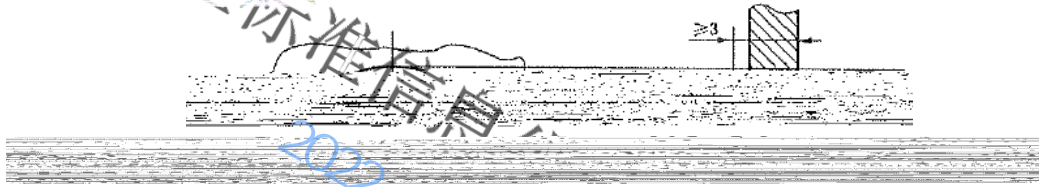

B1

企业标准  
2022 07 22 19 27

2022 07 22 19 27

**c**

( )

.

C1

C2

( )

( )

( )

( 6.2)

C3





( 11.2.3)

(

)

(

)

( )

( N)

( )

( )

C4

a)

b)

GB/T 4728

C5

(

)

企业标准信息

2022

07

22

19

27

2022

07

22

19

27



D

( )

企业标准信息公共服务平台

D1

- a)
- b)
- c)
- d)

( C )

D2

- a)
- b)
- c)

( 7.7 )  
 ( A )

[ 16.2a)];

- d)

( 12.4);

125

- e)
- f)
- 1)

( 12.6)

( 13.1.3)

- 2)

- g)
- h)

( 10.5 )  
 ( 9.3 )

- 1)

—  
 —  
 2)  
 3)  
 —  
 —

125



3) 8.2.2 125 1 1) 2)  
1

8.2.2 150  
i) 1) ( 9.9.1 9.9.2) ( ) ( 9.9.3)

2) 9.9.11.1 9.9.11.2

j) ( 9.8) ( F3)

1)

2) 125

8.2.2 1 1  
125

8.2.2<sup>1</sup> 150 125

( )

k) ( ) ( 9.8)

( F3)

( )

( )



1)

2)

( )

L) ( 10.3 10.4)

1)

( )

C5

C3

2)

( 10.4.3.2)

8.2.2

1

1

m)

( 14.2.3)

n)

( 9.10)

o)

9.11

9.11

---

---

9.11.5

9.11.3



E

( )

E1

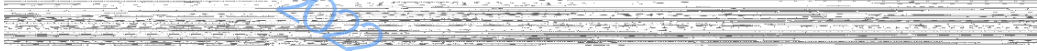

E2

16.2

16.2

a)

b)



F

( )

F0  
F0.1  
F0.1.1

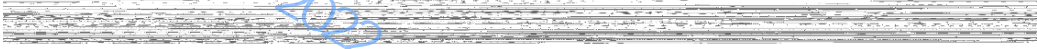

F0.1.2

F0.1.3  
F0.1.4  
F0.1.5

F0.1.6

a)  
b)  
c)  
d)  
e)  
F0.2

±1

±2

±5

±5

0.01s

企业标准信息公共服务平台  
2022 07 22 19 27



企业标准信息公共服务平台

2022 07 22 19 27

1.

2.

3.

4.

5.

6.

7.

8.

9.

10.

2022 07 22 19 27



F1  
F1.1  
F1.1.1

F1.1.2

F1.1.3

F1.1.3.1

a)

b)

c)

d) [ ( ) ]

F1.1.3.2

F1.1.4

F1.2

F1.2.1

a)

7mm 7.7.3.1.1

b)



F1.2.2

7.7.5.1



b) 200V 2A

F1.2.4.2.1

5 10 s  
50

0.5s

0.7±0.05

11

F1.2.4.2.2

110

5 10 s  
20

0.5s

300ms  
110

95

F1.2.4.2.3

F1.2.4.4

14.1.2.2.3

F1.2.4.5

14.1.2.2

F1.3

F1.3.1

7.7.6.1

7.7.6.2

F1.2

F1.3.2

F1.3.2.1

F1.2.2.2

F1.3.2.2

F1.4

F1.4.1



F1.4.2

a)F0.2

b)

c)

d)

企业标准信息  
2022 07 22 19 27

F2

F3

F3.1

a)

b)

F3.2

F3.2.1

F3.2.2

F3.2.2.1

a)

b)

F3.2.2.2

a)

b)

c)



F3.2.3

F3.2.3.1

a)

b)

F3.2.3.2

a)

b)

1)

2)

F3.2.4

F3.2.4.1

9.9.1

$$h = \frac{v_1^2}{2g_n} + 0.10 + 0.03$$

h—

m

$v_1$ —

m/s

0.10—

m

0.03—

m

$$2K = (P+Q)_1 \times g_n \times h$$

$$(P+Q)_1 = \frac{2K}{g_n \times h}$$

$(P+Q)_1$ —

kg

P—

kg

Q—

kg

K—

J

F3.2.4.2

a)

K F3.2.3.2.a)

2

(kg)

$$(P+Q)_1 = \frac{K}{g_n \times h}$$



b)

1)  $K_1$  F3.2.3.2b)1)

2

(kg)

$$(P+Q)_1 = \frac{K_1}{g_n \times h}$$

2)  $K_2$  F3.2.3.2b)2)

3.5

(kg)

$$(P+Q)_1 = \frac{2K_2}{3.5 \times g_n \times h}$$

$K_1$   $K_2$ —

J

F3.2.5

F3.3

F3.3.1

F3.3.1.1

(kg)

(m/s)

(N)

16

(kg)

$0.6g_n$

F3.3.1.2

F3.3.2

F3.3.2.1

a)

b)

c)

d)

a) b)

1)

2)

3)

F3.3.2.2



F3.3.2.2.1

- a)
- b)

4m/s

4m/s

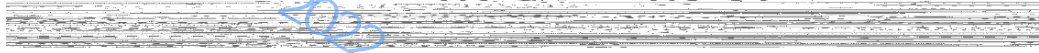

F3.3.2.2.2

- a)
- b)

( )

F3.3.2.3

F3.3.2.3.1

25%

F3.3.2.3.2

( )

F3.3.2.3.1

F3.3.2.4



a)

b)

)

c)

F3.3.3

F3.3.3.1

(P+Q)1= /16

—

F3.3.2.3

N

F3.3.3.2

F3.3.3.2.1

F3.3.3.1

F3.3.3.2.2

F3.3.3.1

F3.3.4

20

F3.3.3.1

F3.4

a)1)

2)

7.5

9.8.4

F3.3.3

±

b)

c)

(

)

d)

e)

F3.5

F3.5.1

F3.5.2



a)F0.2

b)

c)

[ F3.4a)];

d)

e)

f)

g)

h)

( )

i)

F4

F4.1

a)

b)

c)

F4.2

F4.2.1

a)

b)

c)

F4.2.2

F4.2.2.1

a)

b) 9.9.11.1

)

c) 9.9.11.2

d)

F4.2.2.2

[ F4.1b)

]





1  
 2  
 3  
 F4.2.2.3  
 F4.2.2.3.1 20 9.9.1 20  
 F4.2.2.3.2 20 F4.2.2.1b) c) 9.9.11.1  
 9.9.11.2  
 F4.2.2.3.3 300N

1 180  
 2

F4.3  
 F4.3.1  
 F4.3.2  
 a)F0.2  
 b)  
 c)  
 d)  
 e)  
 f)

F5  
 F5.1

a) ( )

b)  
 F5.2

a)  
 b)  
 F5.3  
 F5.3.1  
 F5.3.1.1  
 F5.3.1.1.1

企业标准  
 2022 07 22 19 27



a) 
$$v \leq \sqrt{\frac{Fl}{0.135}} \quad (10.4.1.1.1)$$

1 m/s(10.3.3)

FL—

m

b)

1) Cr/2.5

2) Cr/4

Cr—

k8

F5.3.1.1.2 ( )

F5.3.1.2

F5.3.1.2.1 ( )

( )

FO.1.6

F5.3.1.2.2

F5.3.1.2.3 ( )

F5.3.1.3 ( )

F5.3.1.4

F5.3.1.5

F5.3.2

F5.3.2.1

F5.3.2.2

F5.3.2.2.1

FO.1.6

F5.3.2.2.2

FO.1.6

)

(  
1 000 Hz

F5.3.2.2.3

FO.1.6

F5.3.2.2.4

( ) ( 5.3.2.1)

F0.1.6

F5.3.2.2.5

0.01 s

F0.1.6

F5.3.2.3

(15 25)

F0.1.6

F5.3.2.4

F5.3.2.5

F5.3.2.6

F5.3.2.6.1

10.4.3.3

F5.3.2.6.2



F5.3.2.7

F5.3.3

F5.3.3.1

F5.3.3.1.1

0.8m/s

F5.3.3.1.2

0.9 gn

F5.3.3.2

F5.3.2.2.2 F5.3.2.2.3 F5.3.2.2.4

F5.3.3.3

(15— 25)

F5.3.3.4

F5.3.3.5

a)

b)

(5 30)min

50

F5.3.3.6

F5.3.3.6.1

“ ”

a)

1.0gn

( n)

b) 2.5gn

0.04s

F5.3.3.6.2

F5.3.3.7

F5.4  
F5.4.1

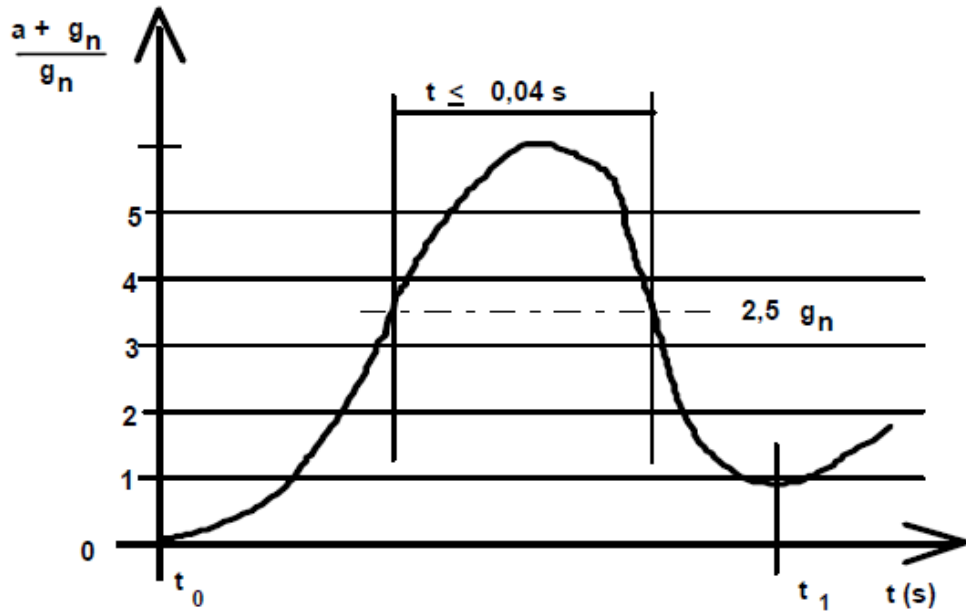

$t_0$ —撞击缓冲器瞬间(第1个绝对值最小时);  $t_1$ —第2个绝对值最小时  
图F1 减速图

- F5.4.2  
a)F0.2  
b)  
c)  
d)  
e)  
f)  
g) ( )  
F6

F6.1

- a)  
b)  
c)  
d)



f)  
g)  
F6.2

a)  
b)  
F6.3  
F6.3.1

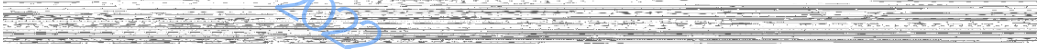

F6.3.1.1

a)GB/T 2423.10— 1995 C2  
20

0.35mm 5gn 10 Hz 55

Hz

b)GB/T 2423.5— 1995 1  
1) 294m/s<sup>2</sup> 30g  
2) 11 ms  
3) 2.1 m/s

F6.3.1.2 (GB/T 2423.6)

a)  
b)

F6.3.1.2.1

a)  
b) 15 g  
c) 11 ms

F6.3.1.2.2

a) 10g  
b) 16ms  
c)1) 1 000+10  
2) 2/s

F6.3.2 (GB/T 2423.22)



0'C 65'C( )

a)

b)

c)

d)

e)

企业标准信息 (0 65 ) ( 4 h )

F6.4

F6.4.1

F6.4.2

a)F0.2

b)

c)GB/T 16935.1

d)

e)

F7

F3 F4 F6

F7.1

a)

b)

c)

a)

b)

c)

F7.2

F7.2.1

(kg)

(m/s)

F7.2.2



- a)
- b) F3 F4 F6

F7.3  
F7.3.1

- a)
- b)
- c)

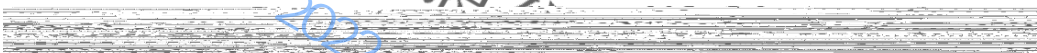

F7.3.2

F7.1b)

20

F7.3.2.1

- a)
- b)

4 m/s  
4m/s

F7.3.2.2

( )

)

F7.3.2.3  
F7.3.2.3.1

20

F7.3.2.3.2

20

9.10.1

F7.3.3

- a)





b)

)

(

c)

d)

F7.4

1 zo

20

F7.5

a)

b)

c)

d)

e)

f)

g)

F7.6

F7.6.1

F7.6.2

a)F0.2

b)

c)

d)

e)

F8

F8.1

—

—

—

—

—

1

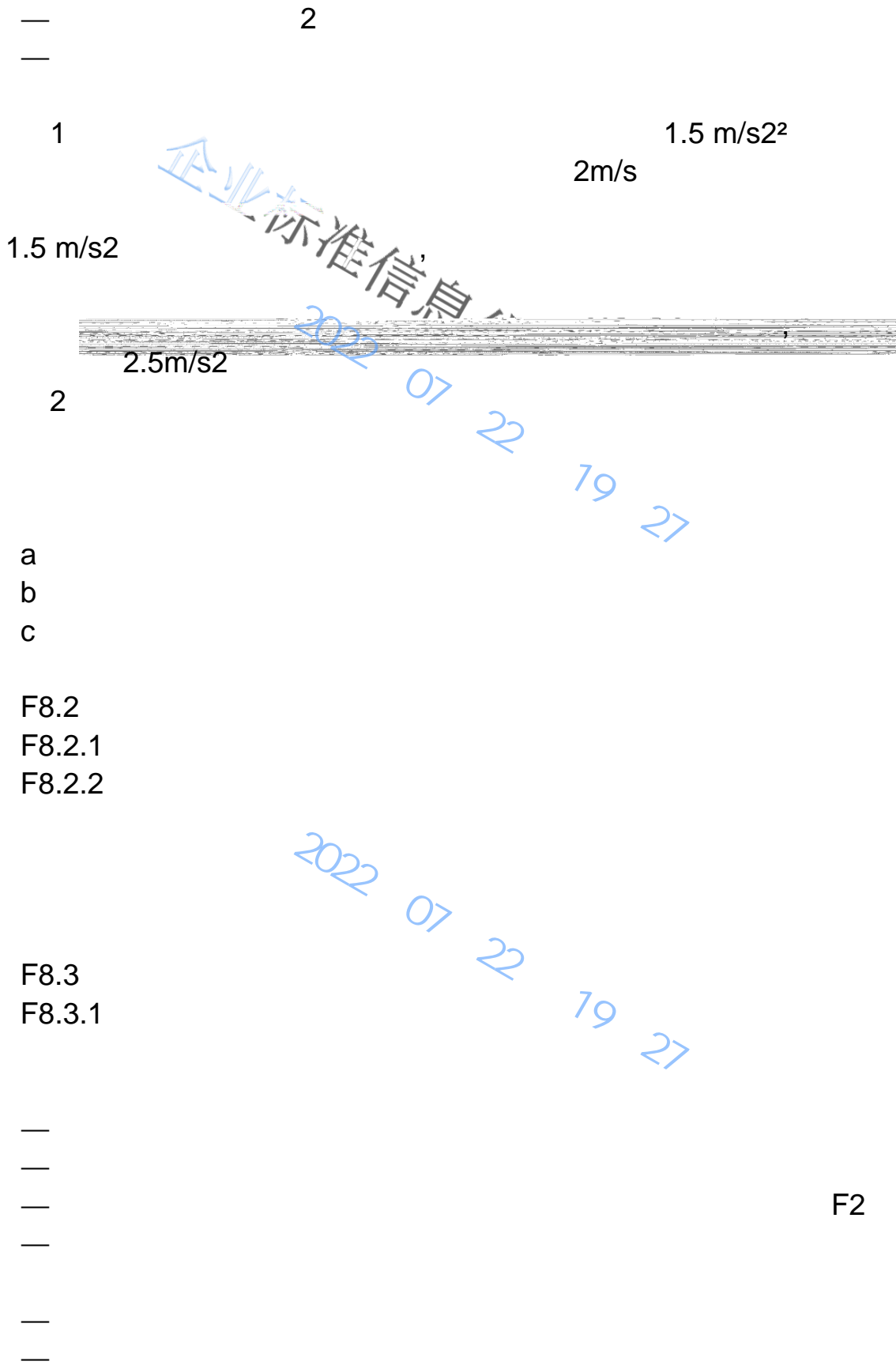

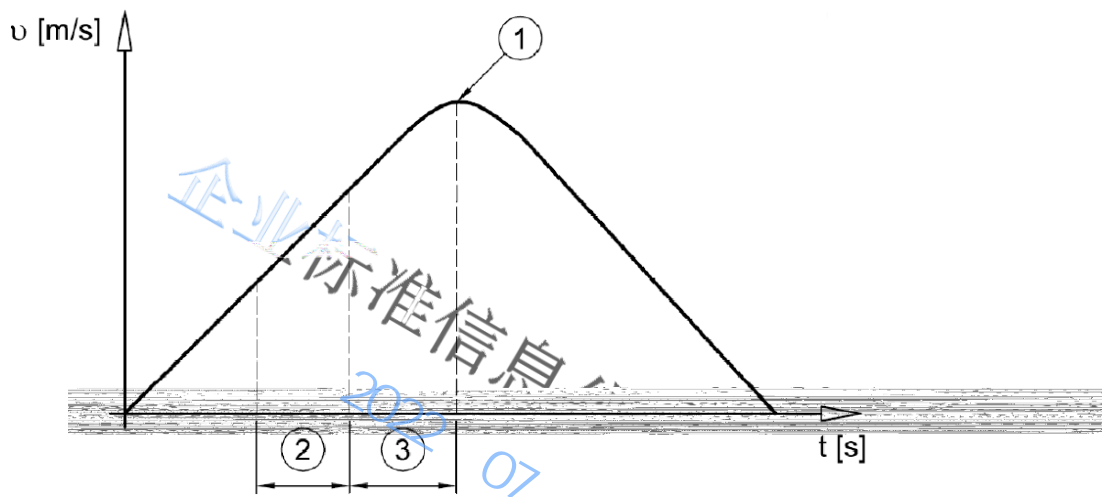

—  
—  
—

F2

F8.3.2

20

—  
—

± 20 %

GB/T 24478-2009 4.2.2.4

F8.3.2.1

2022 07 22 19 27

10

10

5

F8.3.2.2

F8.3.2.3

10



F8.3.2.4  
10

F8.3.3

a

b

c

F8.4

19 27  
20 %

F8.5

—  
—  
—  
—  
—  
—  
—

F8.6

a F0.2

b

c

d

e

f

g)

/



G

( )

G1

G1.1 10.1.1

G1.1.1

Q

G2.2

G1.1.2

G2

G2.1

( )

P

G2.2

“

”

“

”

8.2

Q G7

3/4

(0.25)

G2.3

F<sub>k</sub>

$$F_k = \frac{k_1 g_n (P + Q)}{n}$$

k<sub>1</sub>——

G2

n——

G2.4

F<sub>c</sub>

$$F_c = \frac{k_1 g_n (P + qQ)}{n} \quad \text{或} \quad F_c = \frac{k_1 g_n qP}{n}$$

q——

G2.5

F<sub>s</sub> 0.4g<sub>n</sub>Q

2500k8

F<sub>s</sub> 0.6g<sub>n</sub>Q

2500kg

F<sub>s</sub> 0.85g<sub>n</sub>Q

2500kS



G2 6

G

a)

b)

c)

( )

5

10

G2 7

M

G2 8

WL

(0.25)

G3

G3 1

G

表G1

工 况	载 荷 和 外 力	P	Q	G	F <sub>s</sub>	F <sub>k</sub> 或F <sub>c</sub>	M	WL
-----	-----------	---	---	---	----------------	--------------------------------	---	----

G3 2

G4

G4 1

G4 2

(4

K2

(P+Q)

G4 3

G2 6

K3

1gn

G4 4

G2



表G2

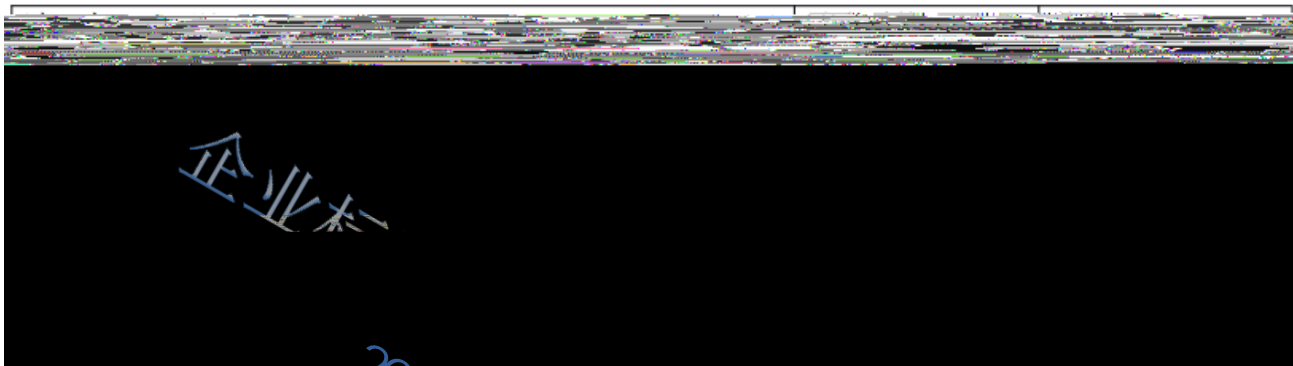

企业标准

2022 07 22 19 27

G5

G5.1

( )

G5.2

G5.2.1

a)

b)

c)

G5.2.2

( G1)

a)

L

b)

c)

2022 07 22 19 27

m

M

3E.I

m—

N/mm<sup>2</sup>

M<sub>a</sub>—

Nmm

W—

mm<sup>3</sup>

F<sub>b</sub>—

N

l—

mm

“

”

G5.2.3

W<sub>x</sub>

W<sub>y</sub>

(

)



G5.2.4

G5.2.5 9.8.2.2

G5.2.5.1

G5.2.5.2 G2.3

G2.4

G5.3

“ ”



k——	N/mm <sup>2</sup>	MPa		
F <sub>k</sub> ——			N	G2.3
F <sub>c</sub> ——			N	G2.4
K <sub>3</sub> ——	G2			
M——			N	
A——	mm <sup>2</sup>			
	G3	370MPa	G4	520MPa

$$\lambda = \frac{l_k}{i} \quad \text{和} \quad l_k = l_2$$

l <sub>k</sub> ——	mm		
i——	mm		
	R <sub>m</sub> 370 MPa		
20	60	0.000 129 20×	1.89 +1
60<	85	0.000 046 27×	2.14 +1
85<	115	0.000 017 11×	2.35 +1.04
115<	250	0.000 168 87×	2.00





Rm 520MPa

20	50	0.000 082 40x	2.06 +1.021
50x	70	0.000 018 95x	2.41 +1.05
70x	89	0.000 024 47x	2.36 +1.03
89x	250	0.000 253 30x	2.00

370MPa 520MPa

$$\omega_R = \left[ \frac{\omega_{520} - \omega_{370}}{520 - 370} \times (R_m - 370) \right] + \omega_{370}$$

表G3 19

$\lambda$	0	1	2	3	4	5	6	7	8	9	$\lambda$
20	1.04	1.04	1.04	1.05	1.05	1.06	1.06	1.07	1.07	1.08	20
30	1.08	1.09	1.09	1.10	1.10	1.11	1.11	1.12	1.12	1.12	20

2022 07 22 19 27



表G4

$\lambda$	0	1	2	3	4	5	6	7	8	9	$\lambda$
20	1.06	1.06	1.07	1.07	1.08	1.08	1.09	1.09	1.10	1.11	20
30	1.11	1.12	1.12	1.13	1.14	1.15	1.15	1.16	1.17	1.18	30
40	1.19	1.19	1.20	1.21	1.22	1.23	1.24	1.25	1.26	1.27	40

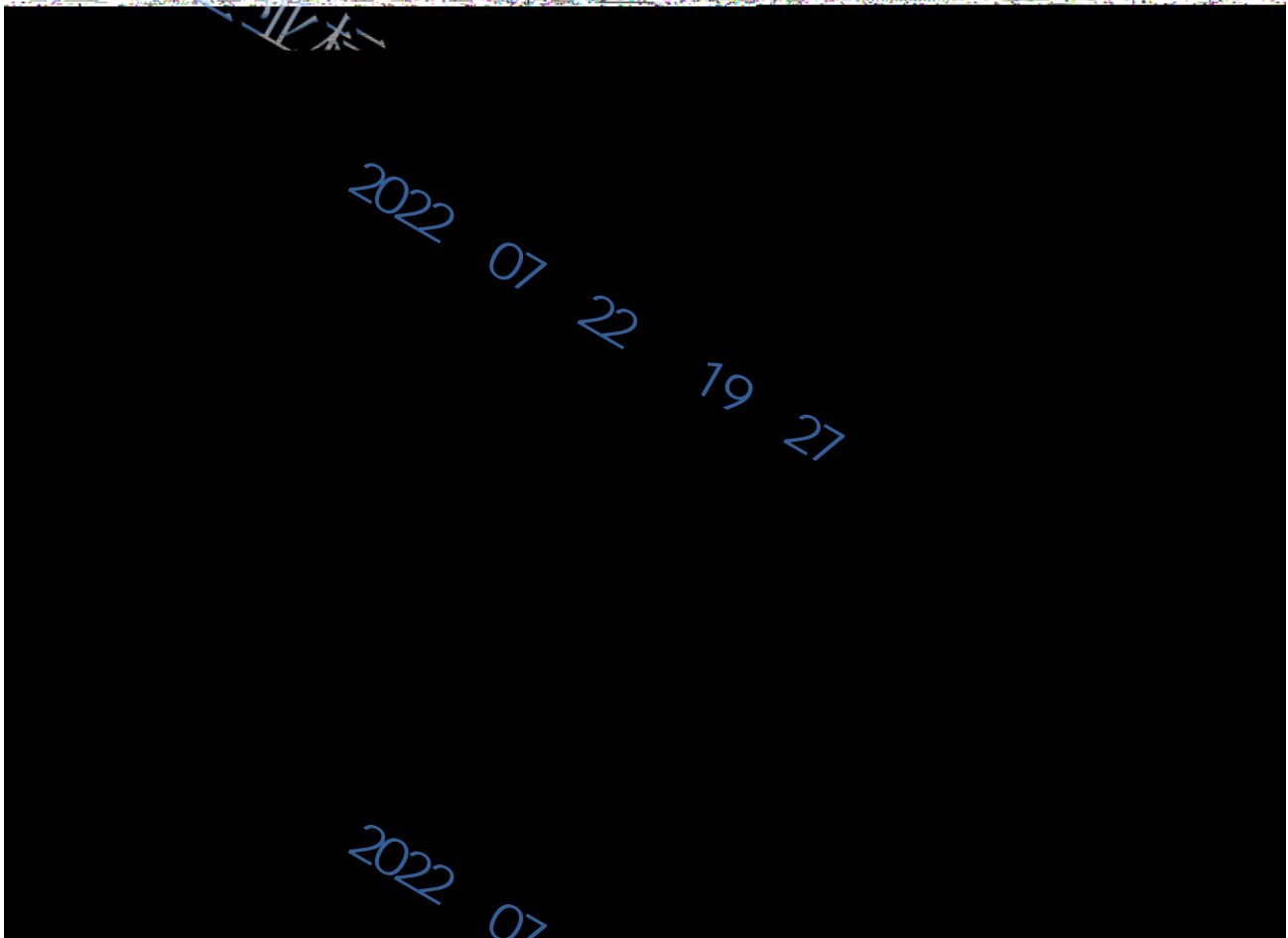

G5.4

m x+ y  
perm

x —X  
y—Y  
perm—

Mpa  
Mpa  
Mpa 10 1. 2 1

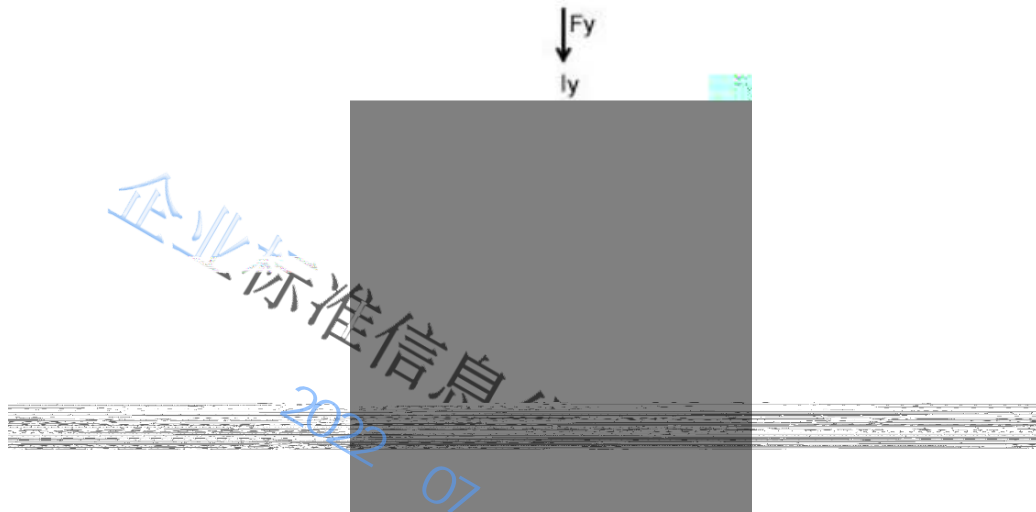

G5.5

T

F——

Mpa

Fx——

N

C——

mm

G1

G5.6

G7

G5.7

$$\delta_y = 0.7 \frac{F_y \cdot l^3}{48 \cdot E \cdot I_x} \quad \text{Y—Y导向面}$$

$$\delta_x = 0.7 \frac{F_x \cdot l^3}{48 \cdot E \cdot I_y} \quad \text{X—X导向面}$$

x——X

mm

y——Y

mm

Fx——X

N

Fy——Y

N

E ——

Mpa

Ix—— X

mm<sup>4</sup>

Iy

mm<sup>4</sup>

——Y

G6

T

10.1.2.2

10.1.1



1Q 1. 1

G7

( )

( Q)

Dx—X

Dy—Y

xc, yc—

xs, ys—

xp, yp—

xcp, ycp—

S—

C—

P—

Q—

—

1, 2, 3, 4—

xi, yi—

n—

h—

xQ yQ—

xcQ ycQ—

C

S

P

P

—

—

1, 2, 3, 4

i=1, 2, 3, 4

Q

C

Q

X

Y

DX

y

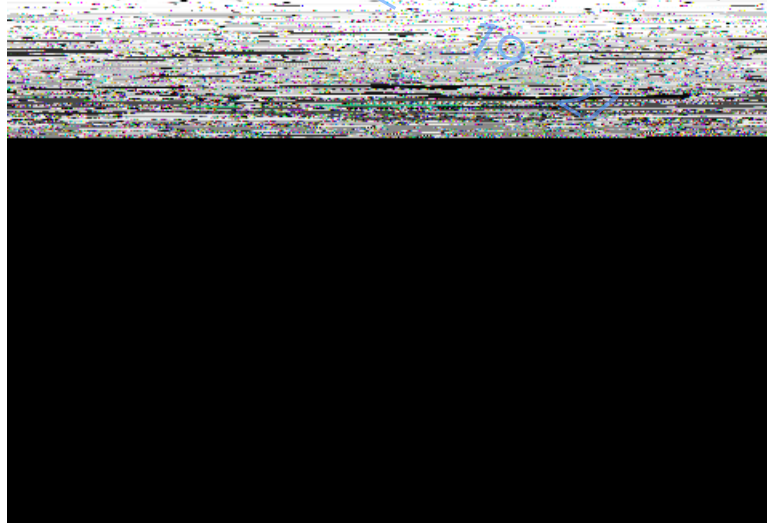

G7. 1  
 G7. 1. 1  
 G7. 1. 1. 1

a)

Y

$$F_x = \frac{k_1 \cdot g_n \cdot (Q \cdot x_Q + P \cdot x_P)}{n \cdot h}, \quad M_y = \frac{3 \cdot F_x \cdot l}{16}, \quad \sigma_y = \frac{M_y}{W_y}$$

b)

X

$$F_y = \frac{k_1 \cdot g_n \cdot (Q \cdot y_Q + P \cdot y_P)}{\frac{n \cdot h}{2}}, \quad M_x = \frac{3 \cdot F_y \cdot l}{16}, \quad \sigma_x = \frac{M_x}{W_x}$$

X ( G3)

$$v = v + \frac{D_x}{l}$$

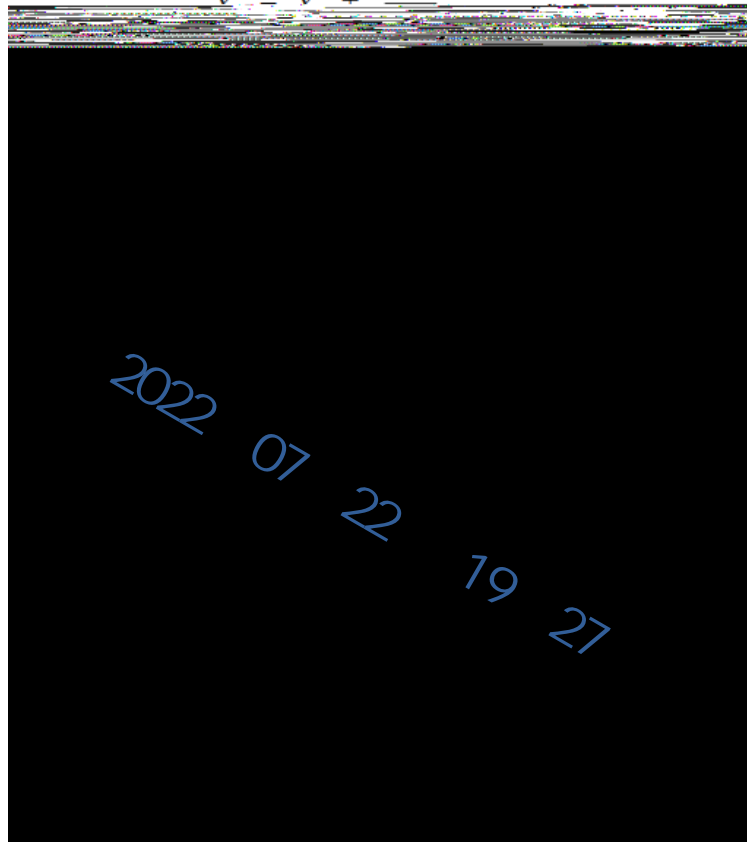

Y ( G4)



$$x_Q = x_c$$

$$y_Q = y_c + \frac{D_y}{8}$$

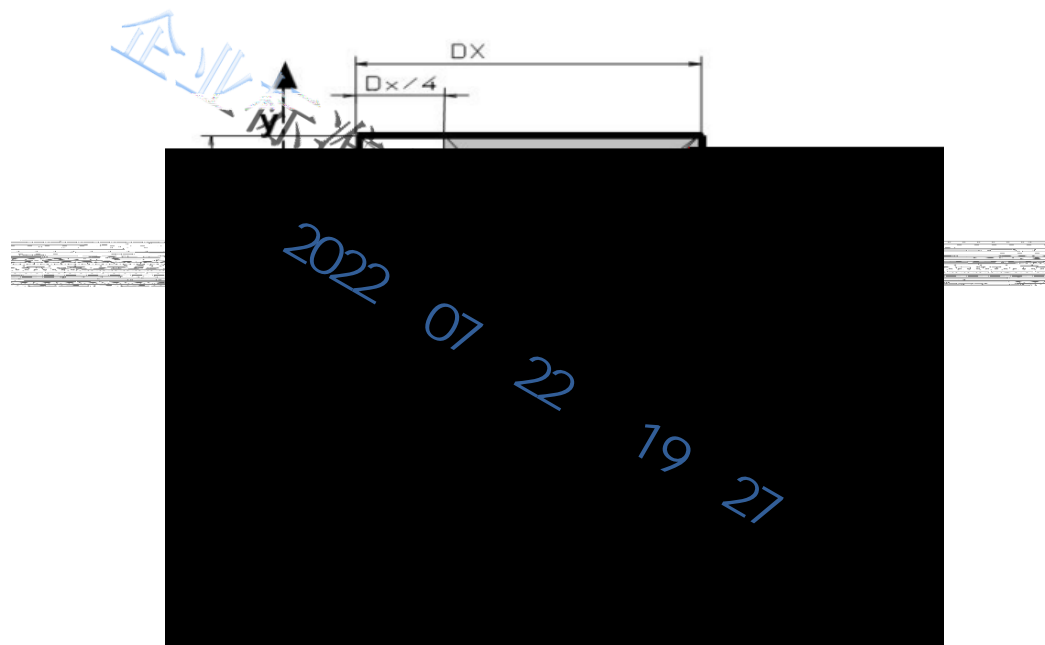

G7. 1. 1. 2

$$\sigma = \frac{k_1 \cdot g_n \cdot (P+Q)}{A} + \frac{(F_k + k_3 \cdot M) \cdot \omega}{I}$$

G7. 1. 1. 3

1)

$$\sigma = \sigma + \sigma < \sigma_{allow}$$

G7. 1. 1. 4

2)

$$\sigma = \frac{1,85 \cdot F_x}{A} < \sigma_{allow}$$

G7. 1. 1. 5

3)

$$\delta = 0,7 \cdot \frac{F_x \cdot l^3}{EI} < \delta_{allow} \quad \delta = 0,7 \cdot \frac{F_y \cdot l^3}{EI} < \delta_{allow}$$

G 1. 2

G7. 1. 2. 1

a)

Y



G7. 1. 3 1

a) Y

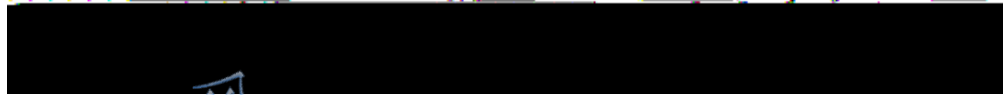

b) X

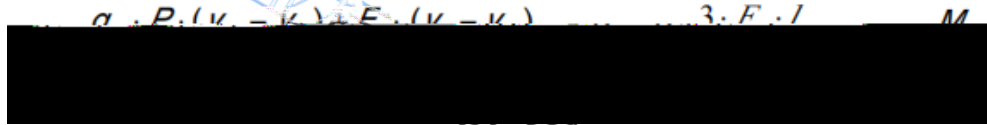

G7. 1. 3 2



G7. 1. 3 3

7(

$$\sigma_m = \sigma_x + \sigma_y \leq \sigma_{perm}$$



G7. 1. 3 4

$$\sigma_F = \frac{185 \cdot F_x}{c^2} \leq \sigma_{perm}$$

G7. 1. 3 5

$$\delta_x = 0,7 \frac{F_x \cdot l^3}{48 \cdot E \cdot I_y} \leq \delta_{perm} \quad \delta_y = 0,7 \frac{F_y \cdot l^3}{48 \cdot E \cdot I_x} \leq \delta_{perm}$$

G7. 2

G7. 2 1

G7. 2 1. 1

a) Y



b) X

$$F_y = \frac{k_1 \cdot g_n \cdot (Q \cdot y_Q + P \cdot y_P)}{\frac{n}{2} \cdot h}, \quad M_x = \frac{3 \cdot F_y \cdot l}{16}, \quad \sigma_x = \frac{M_x}{W_x}$$

X ( 6)

P Q

Q X





$$x_Q = \frac{D_x}{8}$$

$$y_Q = 0$$



图 G6  
Y ( 7 )  
 $x_n = 0$



G7. 2 1. 2

$$F_k = \frac{k_1 \cdot g_n \cdot (P + Q)}{2}, \sigma_k = \frac{(F_k + k_3 \cdot M)}{A} \cdot \omega$$

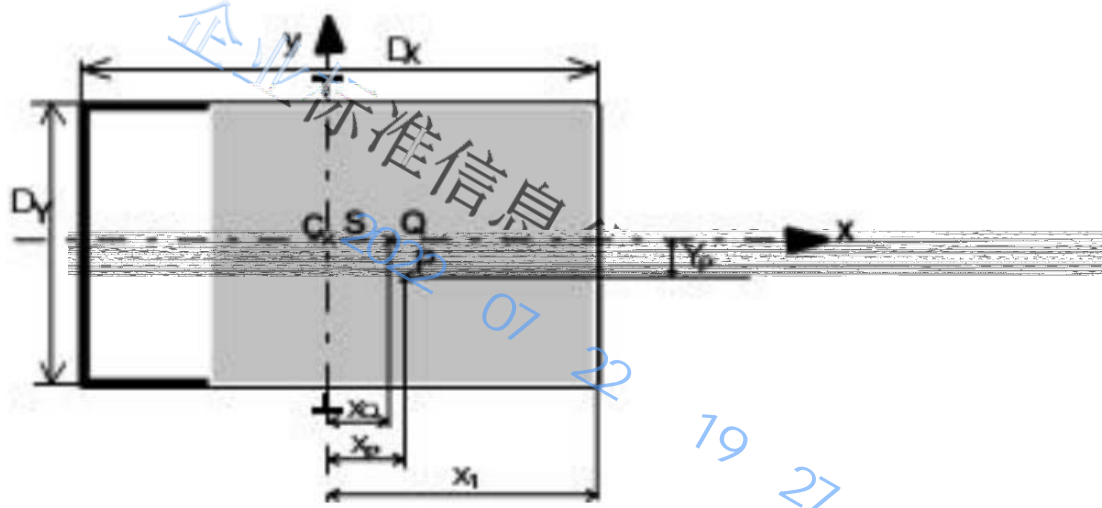
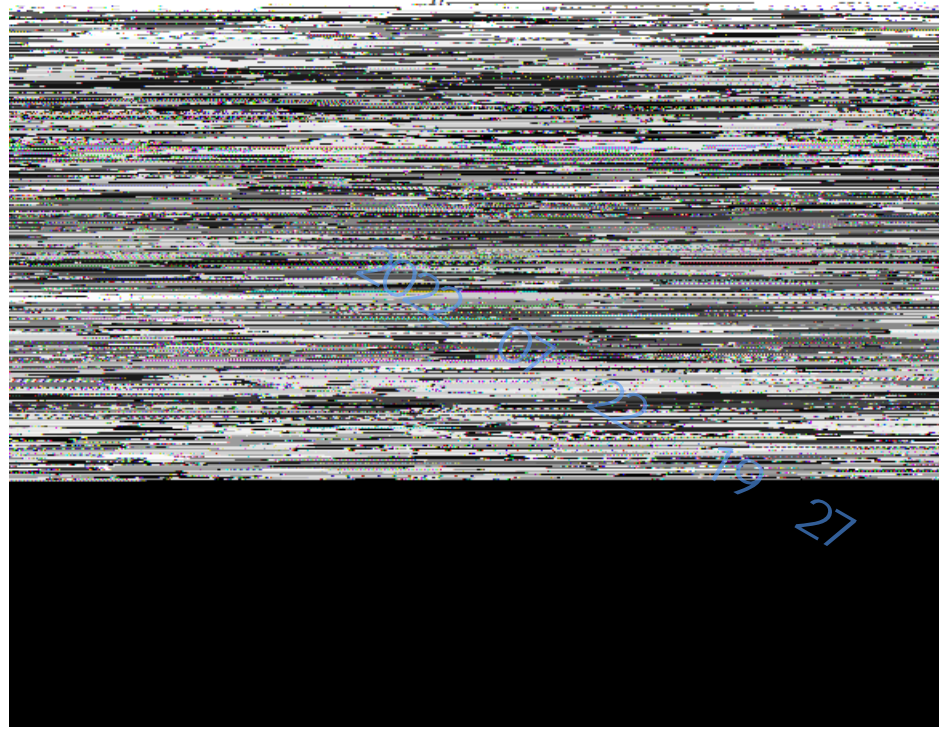
G7. 2 1. 3 8)



$$\sigma_m = \sigma_x + \sigma_y \leq \sigma_{perm}$$

$$\sigma = \sigma_m + \frac{F_k + k_3 \cdot M}{A} \leq \sigma_{perm}$$

$$\sigma_k = \sigma_k + 0,9 \cdot \sigma_m \leq \sigma_{perm}$$

G7.2.1.4

9)



G7.2.1.5

10)

$$\delta_x = 0,7 \frac{F_x \cdot l^3}{EI} \leq \delta_{perm} \quad \delta_y = 0,7 \frac{F_y \cdot l^3}{EI} \leq \delta_{perm}$$

G7.2.2

G7.2.2.1

a)

Y

$$M_y = \frac{k_2 \cdot g_n \cdot (Q \cdot x_Q + P \cdot x_P)}{2} = \frac{3 \cdot F_y \cdot l}{16} = M_y$$

b)

X

$$F_y = \frac{k_2 \cdot g_n \cdot (Q \cdot y_Q + P \cdot y_P)}{\frac{n \cdot h}{2}}, \quad M_x = \frac{3 \cdot F_y \cdot l}{16}, \quad \sigma_x = \frac{M_x}{W_x}$$

X ( G7.2.1.1)

Y ( G7.2.1.1)

G7.2.2.2

"

"

G7.2.2.3

11)

$$\sigma_m = \sigma_x + \sigma_y \leq \sigma_{perm}$$

$$\sigma = \sigma_m + \frac{k_3 \cdot M}{A} \leq \sigma_{perm}$$

G7.2.2.4

12)

$$\sigma_F = \frac{1,85 \cdot F_x}{c^2} \leq \sigma_{perm}$$



G7.2.2.5 13)

$$\delta_x = 0,7 \frac{F_x \cdot l^3}{48 \cdot E \cdot I_y} \leq \delta_{perm} \quad \delta_y = 0,7 \frac{F_y \cdot l^3}{48 \cdot E \cdot I_x} \leq \delta_{perm}$$

G7.2.3

G7.2.3.1

a)

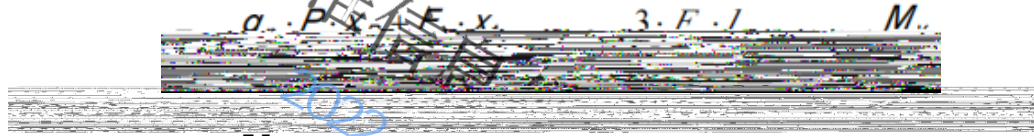

b)

$$F_y = \frac{g_n \cdot P \cdot y_P + F_s \cdot y_1}{h}, \quad M_x = \frac{3 \cdot F_y \cdot l}{16}, \quad \sigma_x = \frac{M_x}{W_x}$$

G7.2.3.2

“ ”

G7.2.3.3

14)

$$\sigma_m = \sigma_x + \sigma_y \leq \sigma_{perm}$$

$$\sigma = \sigma_m + \frac{k_3 \cdot M}{A} \leq \sigma_{perm}$$

G7.2.3.4

$$\sigma_F = \frac{185 \cdot F_x}{c^2} \leq \sigma_{perm}$$

G7.2.3.5

$$\delta_x = 0,7 \frac{F_x \cdot l^3}{48 \cdot E \cdot I_y} \leq \delta_{perm} \quad \delta_y = 0,7 \frac{F_y \cdot l^3}{48 \cdot E \cdot I_x} \leq \delta_{perm}$$

G7.3

G7.3.1

G7.3.1.1

a)

Y

$$F = \frac{k_1 \cdot g_n \cdot (Q \cdot x_Q + P \cdot x_P)}{h}, \quad M = \frac{3 \cdot F_x \cdot l}{16}, \quad \sigma = \frac{M_y}{W_y}$$

b)

X

$$F = \frac{k_1 \cdot g_n \cdot (Q \cdot y_Q + P \cdot y_P)}{h}, \quad M = \frac{3 \cdot F_y \cdot l}{16}, \quad \sigma = \frac{M_x}{W_x}$$

X ( G8)



$$x_Q = x_C + \frac{D_x}{8}$$
$$y_P = y_C = y_Q = y_S = 0$$

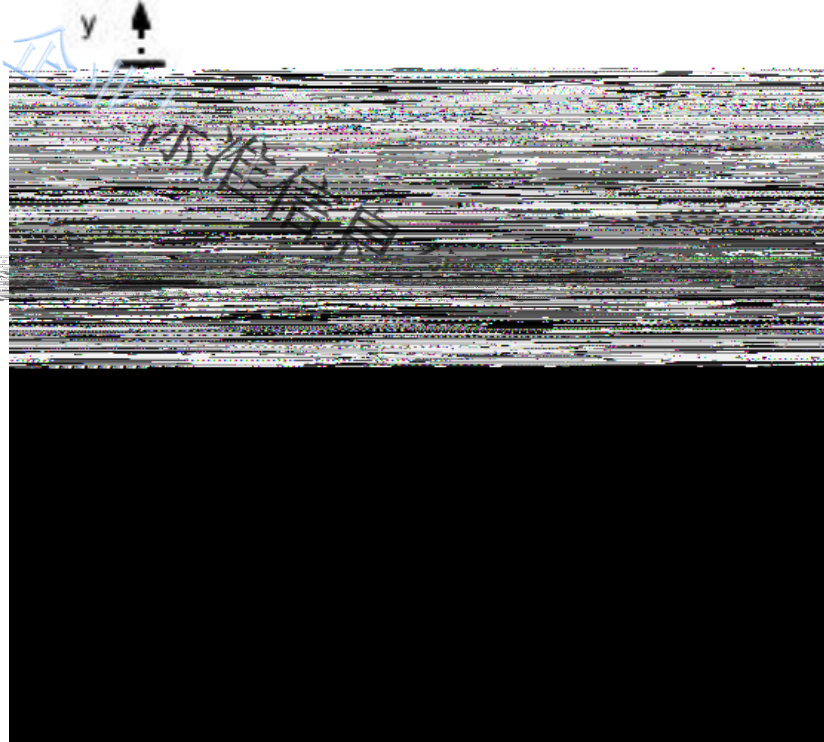

Y ( G)

$$y_Q = \frac{D_y}{8}$$
$$x_C = x_Q$$

G7.3 1.2

$$k \cdot g_n \cdot (P + Q) \quad (F + k \cdot M \cdot \varphi)$$

G7.3 1.3

15)

$$\sigma_x + \sigma_y \leq \sigma_{perm}$$

$$\sigma = \sigma_m + \frac{k_3 \cdot M}{A} \leq \sigma_{perm}$$

$$\sigma_c = \sigma_k + 0,9 \cdot \sigma_m \leq \sigma_{perm}$$

G7.3 1.4

16)

$$185 \cdot F$$

G7.3 1.5

17)

$$\delta_x = 0,7 \frac{F_x \cdot l^3}{48 \cdot E \cdot I_y} \leq \delta_{perm}, \quad \delta_y = 0,7 \frac{F_y \cdot l^3}{48 \cdot E \cdot I_x} \leq \delta_{perm}$$

G7.3 2

G7.3 2.1

a)

Y

$$F_x = \frac{k_2 \cdot g_n \cdot [Q \cdot (x_Q - x_S) + P \cdot (x_P - x_S)]}{n \cdot h}, \quad M_y = \frac{3 \cdot F_x \cdot l}{16}, \quad \sigma_y = \frac{M_y}{W_y}$$

b)

X

$$k_2 \cdot g_n \cdot [Q \cdot (v_Q - v_S) + P \cdot (v_P - v_S)] \quad 3 \cdot F_x \cdot l \quad M$$

X ( G7.2 1.1)

Y ( G7.2 1.1)

G7.3 2.2

“ ”

G7.3 2.3

18)

$$\sigma_m = \sigma_x + \sigma_y \leq \sigma_{perm}$$

$$\sigma = \sigma_m + \frac{k_3 \cdot M}{A} \leq \sigma_{perm}$$

G7.3.2.4 19)

$$\sigma_F = \frac{1,85 \cdot F_x}{c^2} \leq \sigma_{perm}$$

G7.3.2.5 20)



G7.3.3 (G10)



图 G10

G7.3.3.1

a) Y

$$\sigma = \frac{P \cdot (x_c - x_s) + F \cdot (x_c - x_l)}{A} \leq \sigma_{perm}$$

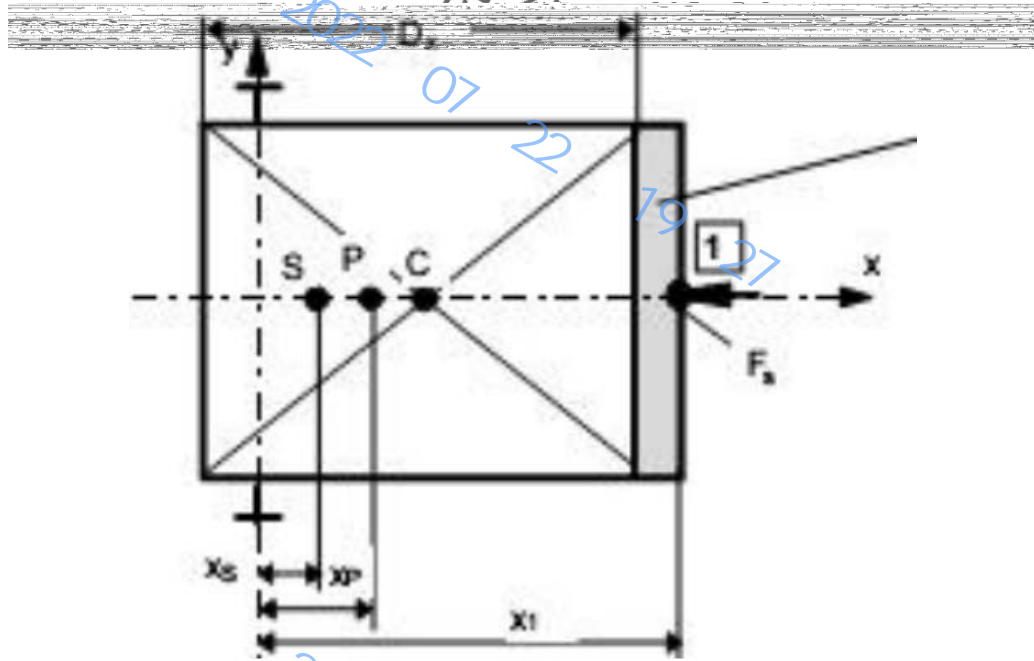
b) X

$$F_y = 0$$

G7.3.3.2

“ ”

G7.3.3.3 21)

$$\sigma_m = \sigma_y \leq \sigma_{perm}$$

$$\sigma = \sigma_m + \frac{k_3 \cdot M}{A} \leq \sigma_{perm}$$

G7.3.3.4

$$\sigma_F = \frac{1,85 \cdot F_x}{c^2} \leq \sigma_{perm}$$

G7.3.3.5

$$\delta_x = 0,7 \frac{F_x \cdot l^3}{48 \cdot E \cdot I_y} \leq \delta_{perm} \quad \delta_y = 0$$

G7.4



Y ( G12)

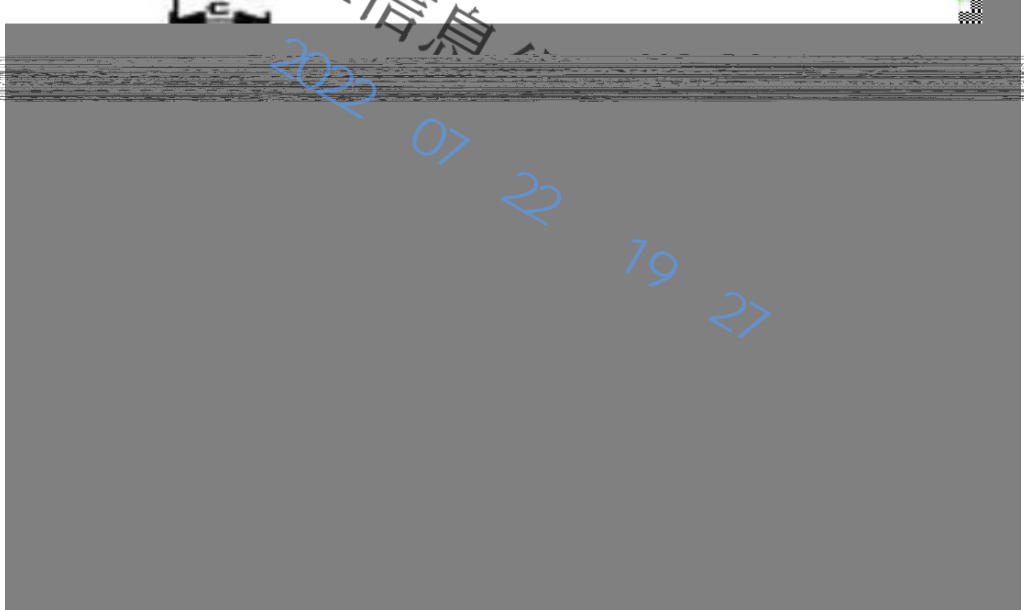
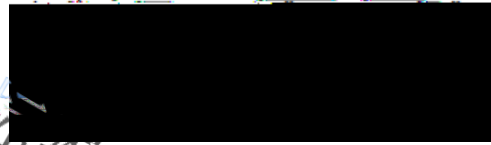

G7.4.1.2

$$F_k = \frac{k_1 \cdot g_n \cdot (P+Q)}{n}, \sigma_k = \frac{(F_k + k_3 \cdot M) \cdot \omega}{A}$$

G7.4.1.3

22)

$$\sigma_m = \sigma_v + \sigma_v \leq \sigma_{norm}$$



G7.4.1.4

23)





G7.4.1.5 24)

$$\delta_x = 0,7 \frac{F_x \cdot l^3}{E \cdot I_y} \leq \delta_{perm}, \delta_y = 0,7 \frac{F_y \cdot l^3}{E \cdot I_x} \leq \delta_{perm}$$

G7.4.2

G7.4.2.1

a)

$$k \cdot \sigma \cdot [Q \cdot (v_0 - v_1) + P \cdot (v_0 - v_1)] \leq \frac{3 \cdot F \cdot l}{M}$$

b)

$$k \cdot \sigma \cdot [Q \cdot (v_0 - v_1) + P \cdot (v_0 - v_1)] \leq \frac{3 \cdot F \cdot l}{M}$$

X ( G7.4.1.1)

Y ( G7.4.1.1)

G7.4.2.2

“ ”

G7.4.2.3

25)

$$\sigma_m = \sigma_x + \sigma_y \leq \sigma_{perm}$$

$k \cdot M$

G7.4.2.4

26)

$$\sigma_F = \frac{1,85 \cdot F_x}{C^2} \leq \sigma_{perm}$$

G7.4.2.5

27)

$$\delta_x = 0,7 \frac{F_x \cdot l^3}{48 \cdot E \cdot I_y} \leq \delta_{perm}, \delta_y = 0,7 \frac{F_y \cdot l^3}{48 \cdot E \cdot I_x} \leq \delta_{perm}$$

G7.4.3



$$x_p > 0 \quad y_p = 0$$

$$x_1 > 0 \quad y_1 = \frac{D_y}{2}$$

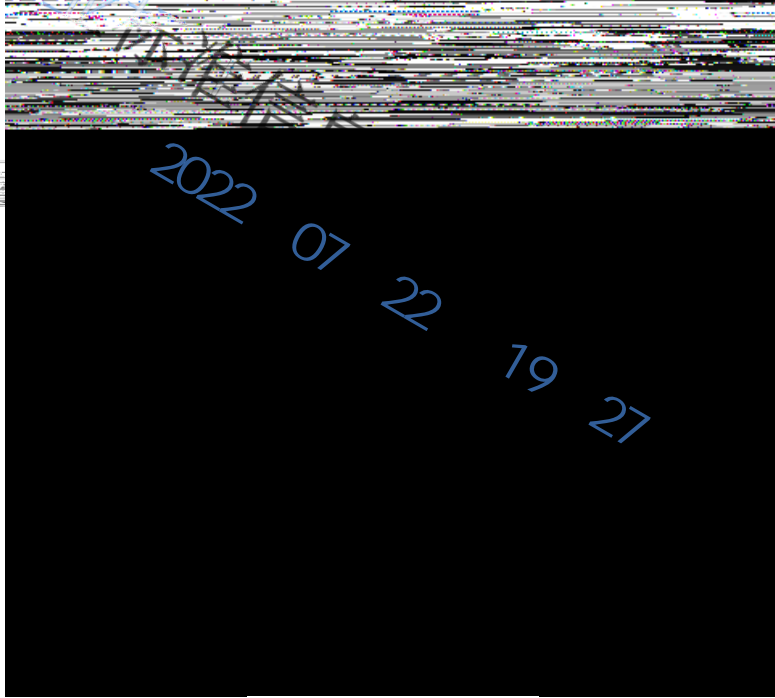

$$x_p > 0 \quad y_p = 0$$

$$x_2 > c + D_x \quad y_2 > 0$$

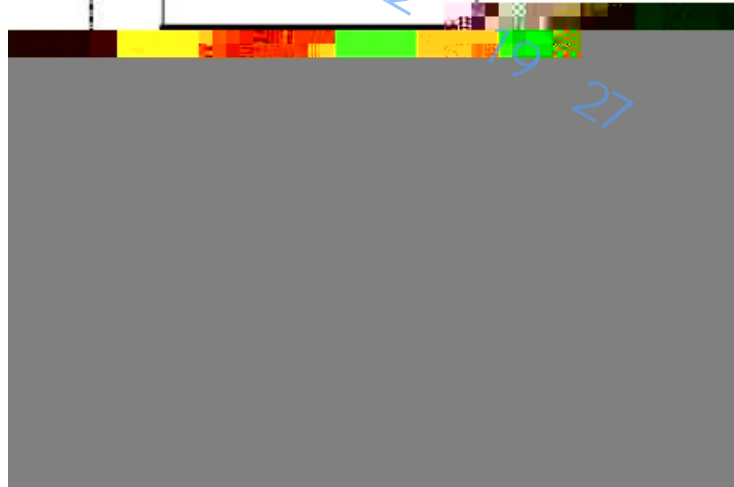
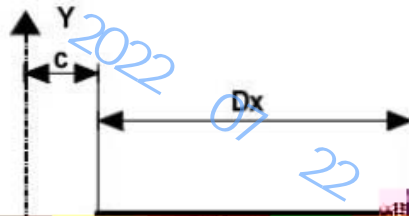

G7.4.3.1

a)

Y

$$F_x = \frac{g_n \cdot P \cdot x_p + F_s \cdot x_i}{n \cdot h}, \quad M_y = \frac{3 \cdot F_x \cdot l}{16}, \quad \sigma_y = \frac{M_y}{W_y}$$

b)

X

$$F_y = \frac{g_n \cdot P \cdot y_p + F_s \cdot y_i}{\frac{n}{2} \cdot h}, \quad M_x = \frac{3 \cdot F_y \cdot l}{16}, \quad \sigma_x = \frac{M_x}{W_x}$$

G7.4.3.2

“ ”

G7.4.3.3

$$\sigma_m = \sigma_x + \sigma_y \leq \sigma_{perm}$$

$$\sigma = \sigma_m + \frac{k_3 \cdot M}{A} \leq \sigma_{perm}$$

G7.4.3.4

$$\sigma_F = \frac{185 \cdot F_x}{c^2} \leq \sigma_{perm}$$

G7.4.3.5

$$\delta_x = 0,7 \frac{F_x \cdot l^3}{48 \cdot E \cdot I_x} \leq \delta_{perm} \quad \delta_y = 0,7 \frac{F_y \cdot l^3}{48 \cdot E \cdot I_x} \leq \delta_{perm}$$

G7.5

G7.5.1

G7.5.1.1

a)

Y

$$k_1 \cdot g_n \cdot (Q \cdot x_Q + P \cdot x_P), \quad 3 \cdot F_x \cdot l, \quad M_y$$

b)

X

$$F_y = \frac{k_1 \cdot g_n \cdot (Q \cdot y_Q + P \cdot y_P)}{\frac{n}{2} \cdot h}, \quad M_x = \frac{3 \cdot F_y \cdot l}{16}, \quad \sigma_x = \frac{M_x}{W_x}$$

X ( G15)

xQ

3/4

yQ 0

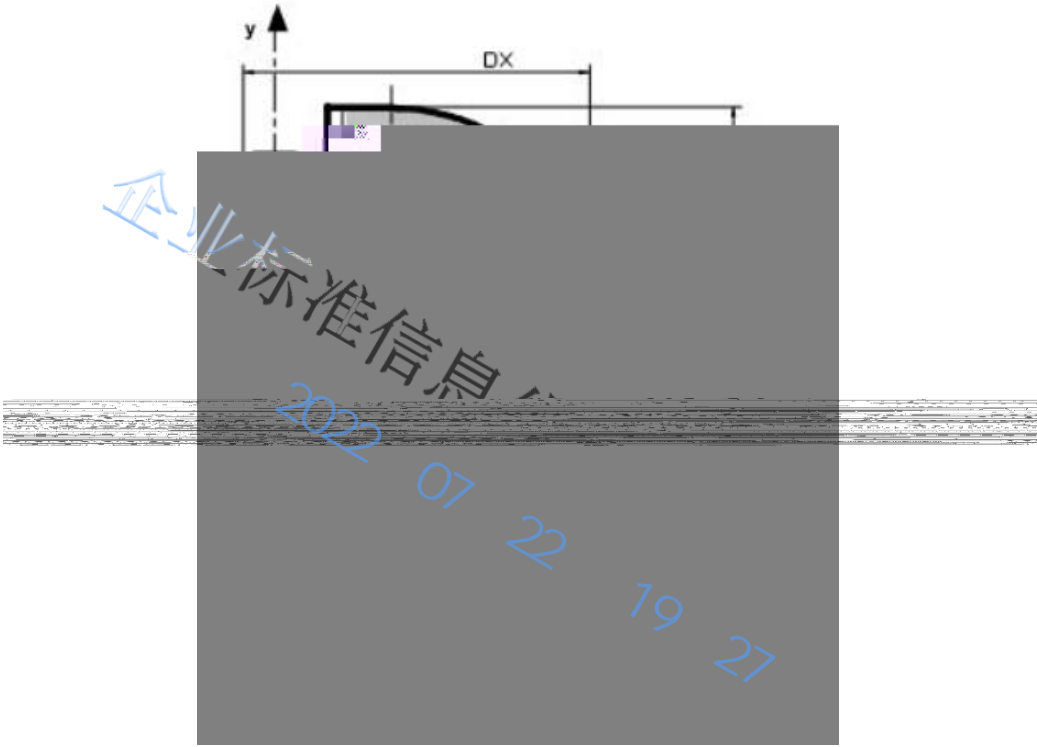

Y ( G16)  
3/4  
xQ yQ



图 G16

G7. 5. 1. 2

G7. 5. 1. 3

29)

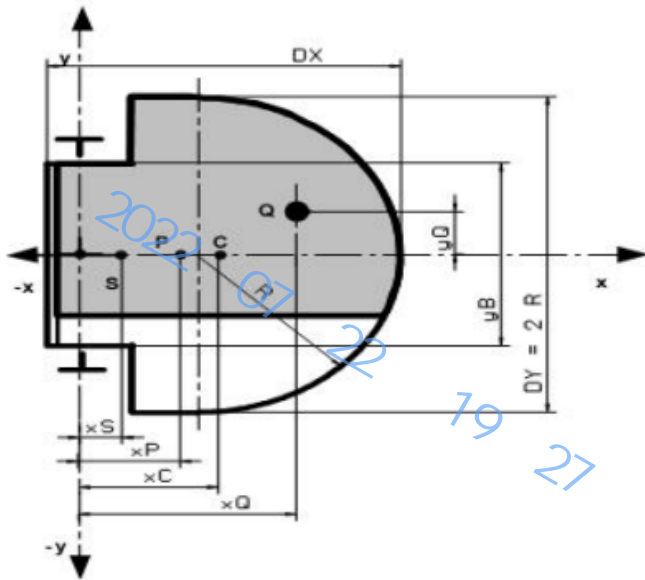
$$\sigma_m = \sigma_x + \sigma_y \leq \sigma_{perm}$$



$$\sigma = \sigma_m + \frac{F_k + k_3 \cdot M}{A} \leq \sigma_{perm}$$

$$\sigma_c = \sigma_k + 0,9 \cdot \sigma_m \leq \sigma_{perm}$$

G7.5.1.4 30)

$$\frac{185 \cdot F_x}{c^2} \leq \sigma_{perm}$$

G7.5.1.5 31)

$$\delta_x = 0,7 \frac{F_x \cdot \dot{P}}{48 \cdot E \cdot I_y} \leq \delta_{perm} \quad \delta_y = 0,7 \frac{F_y \cdot \dot{P}}{48 \cdot E \cdot I_x} \leq \delta_{perm}$$

G7.5.2

G7.5.2.1

a) Y



b) X

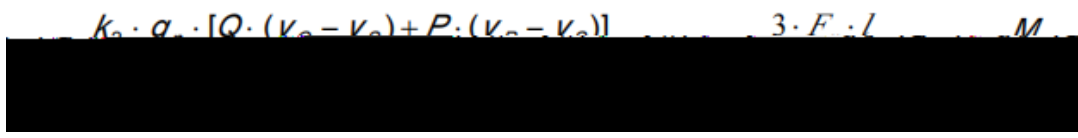

X ( G7.5.1.1)

Y ( G7.5.1.1)

G7.5.2.2

“ ”

G7.5.2.3 32)

$$\sigma_m = \sigma_x + \sigma_y \leq \sigma_{perm}$$

$$k_3 \cdot M$$

G7.5.2.4 33)

$$\sigma_F = \frac{185 \cdot F_x}{c^2} \leq \sigma_{perm}$$

G7.5.2.5 34)

$$\delta_x = 0,7 \frac{F_x \cdot \dot{P}}{48 \cdot E \cdot I_y} \leq \delta_{perm} \quad \delta_y = 0,7 \frac{F_y \cdot \dot{P}}{48 \cdot E \cdot I_x} \leq \delta_{perm}$$



G7.5.3

( G17)

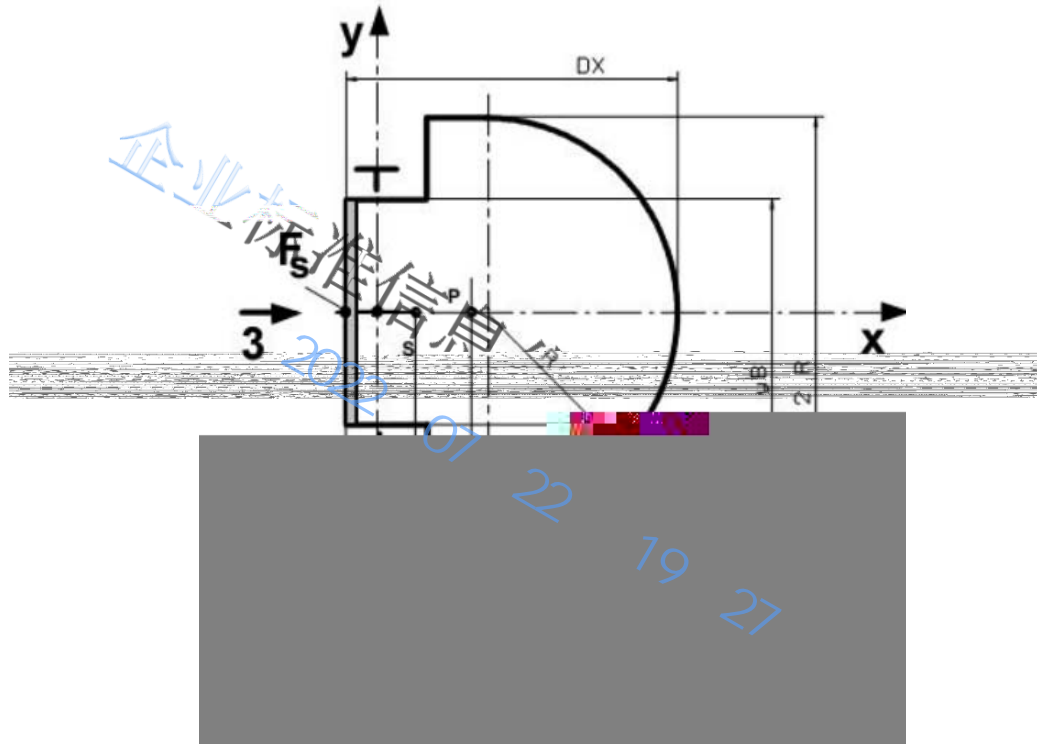

G7.5.3.1

a)

Y

$$F_x = \frac{q_n \cdot P \cdot (x_P - x_S) - F_s \cdot (x_i + x_S)}{n \cdot h}, \quad M_y = \frac{3 \cdot F_x \cdot l}{16}, \quad \sigma_y = \frac{M_y}{W_y}$$

b)

X

$$F_y = 0$$

G7.5.3.2

“

”

G7.5.3.3

$$\sigma_m = \sigma_y \leq \sigma_{perm}$$

$$k_3 \cdot M$$

G7.5.3.4

35)

$$\sigma_F = \frac{185 \cdot F_x}{c^2} \leq \sigma_{perm}$$

G7.5.3.5

$$\delta_x = 0,7 \frac{F_x \cdot l^3}{48 \cdot E \cdot I_y} \leq \delta_{perm}, \quad \delta_y = 0$$



H  
( )

14 1. 1. 1

14 1. 1. 1

企业标准信息公共服务平台

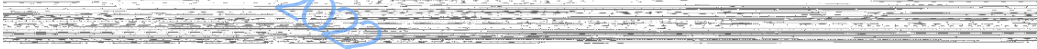

Hl 14 1. 1. 1e)  
“ ”

( )

Hl 3 1 3 6

14 1. 2 4

GB/T 16856

14 1. 2 3

GB 16895. 3

( )



# HI

元 件	可排除故障					条 件	备 注
	断 路	短 路	改 为 更 高 值	改 为 更 低 值	改 变 功 能		
1 无源元件							
1.1 定值电阻	否	(a)		(a)		(a)对根据国家标准进行轴向连接,且由涂漆或封闭处理的电阻膜制成的薄膜电阻器和由漆包线封闭保护的单层绕制的线绕电阻器	
1.2 可变电阻							





2.5 混合电路	否	否	否	否	否		
2.6 集成电路	否	否	否	否	否		功能改变成振荡,与门变成或门等
3 其他元件							

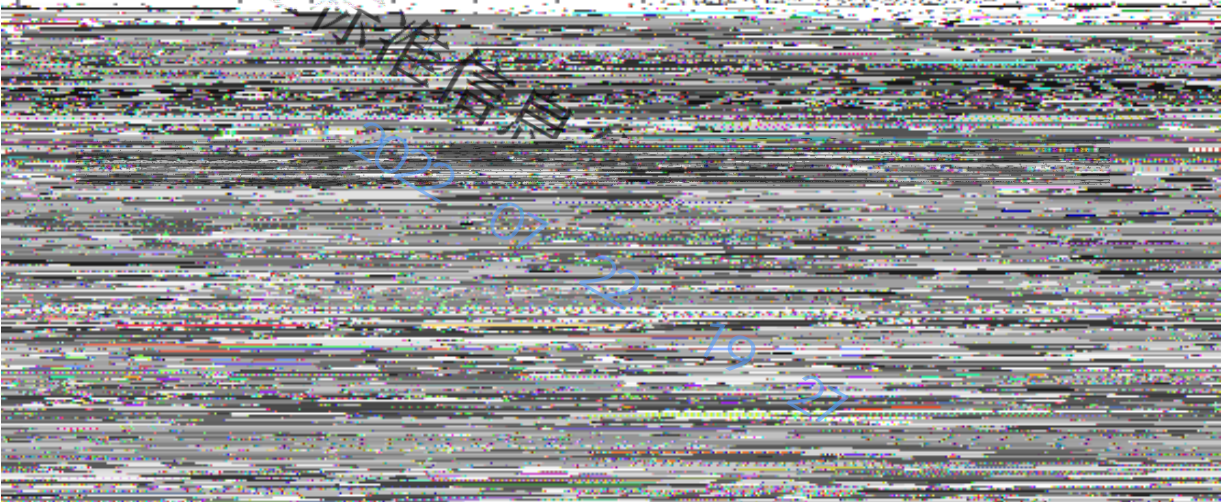

							短路包括初级
--	--	--	--	--	--	--	--------

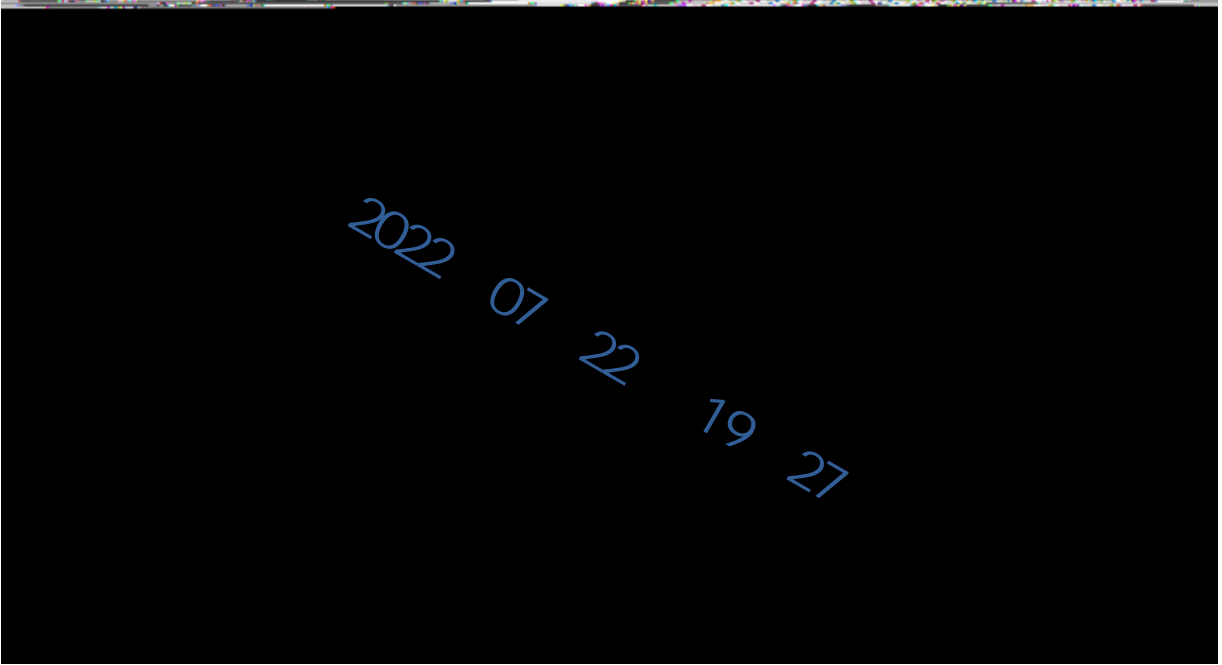

2022 07 22 19 27



					(a)短路排除的条件： -- PCB总体技术条件符合GB/T 16261的要求；
--	--	--	--	--	--

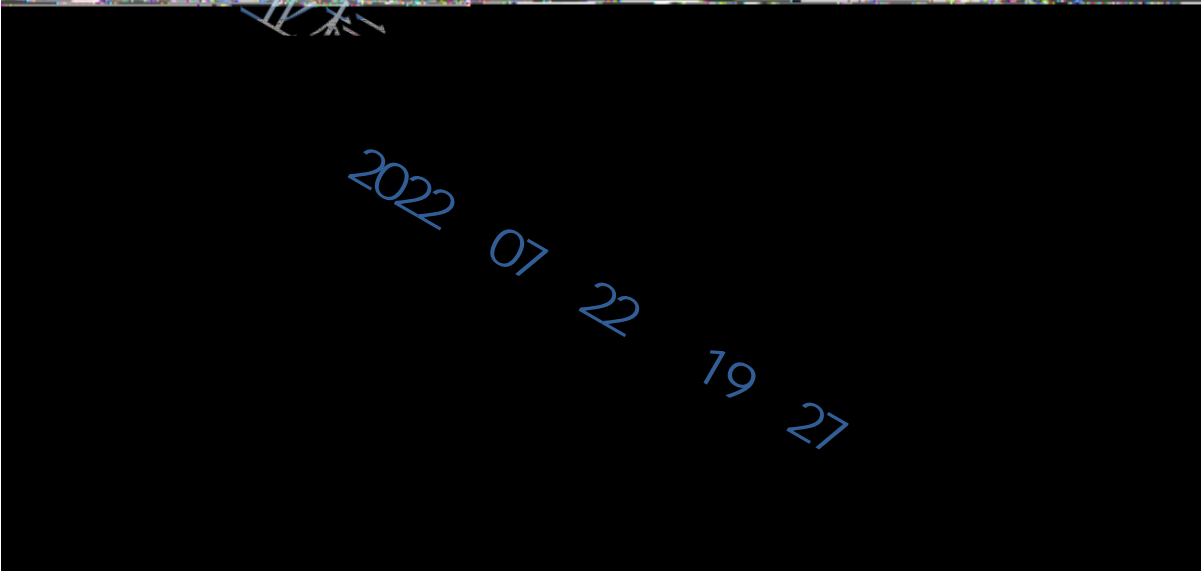

					(a)短路故障可以排除的条件是元件
--	--	--	--	--	-------------------





J  
( )

J1

7.2 3 1 8 3 2 1

8 6 7.1

J2

J2 1

J1 GB/T 700 Q235A

GB/T 700  
(10±

Q275

(3.5± 0.25) mm

0.01) kg

J2 2

J2

(3.5

± 1) mm

(45± 0.5) kg

J2 3

3mm

15mm

( )

1.5m

J2 4

J4 2 J4 3

J3

( )  
( )

J4



J4 1 (23± 2)

4h

J4 2

J2 1

500nm( J3)

J4 3

J2 2

a)

800 nm J3

b)

700 nm J3

J4 4

1.0± 0.1 m

7.2.3.8

J3

J4 5 J2 1 J2 2

J5

J5 1

a)

b)

c)

d)

e)

f)

2mm

J5 2

a)

b)

c)

J6

a)

b)

c)

d)

e)

f)

g)

J7

J1

J2

J1

	1m	2m
	nm	nm
	8	10
	4+Q 76+4	5+Q 76+5
	10	12
	5+Q 76+5	6+Q 76+6

J2

	nm	nm	m	
	16 8+Q 76+8	360-720	2 1	
	16 8+Q 76+8	300-720	2 1	
	10 6+Q 76+4 5+Q 76+5	300-870	2 1	

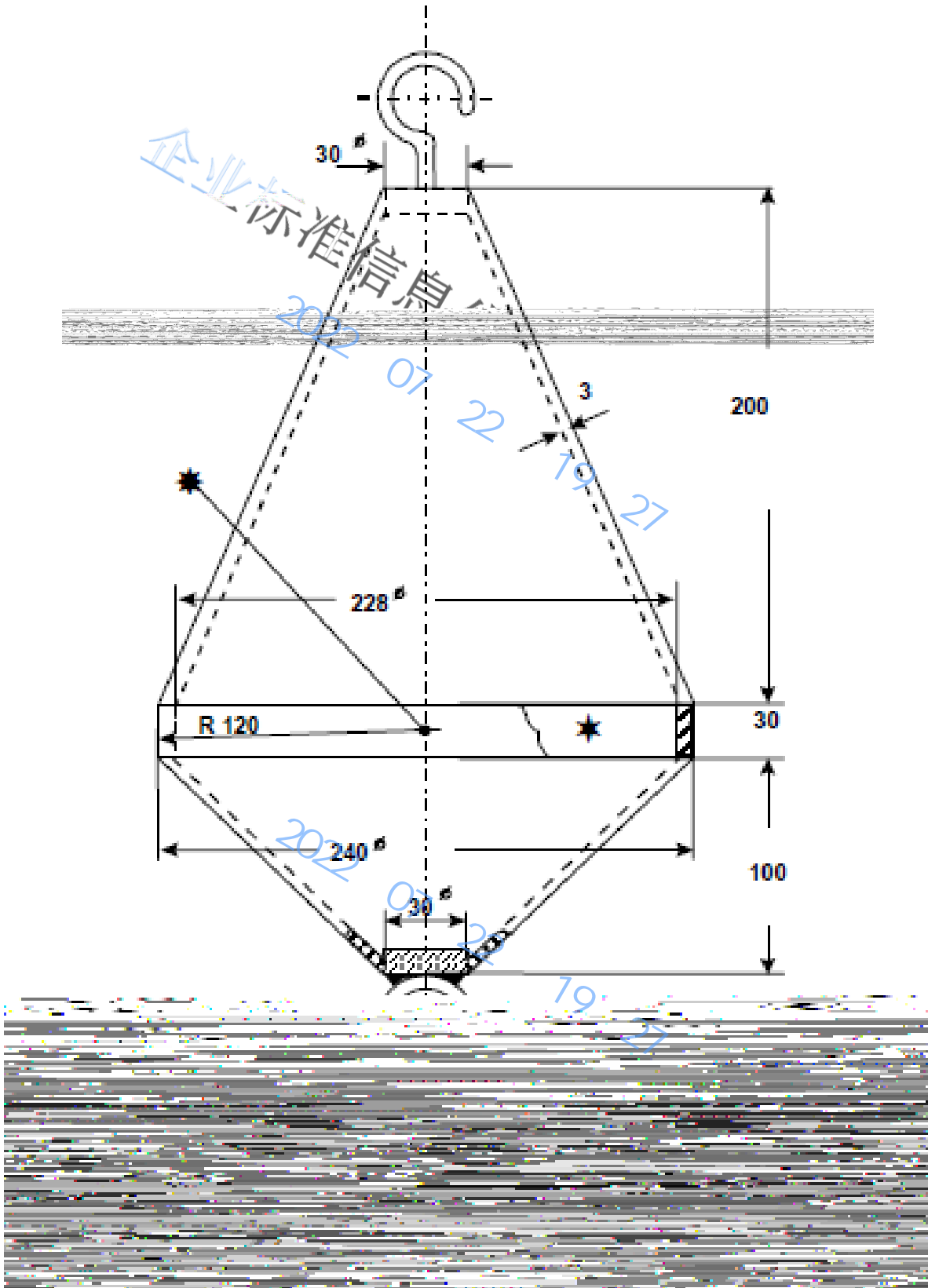

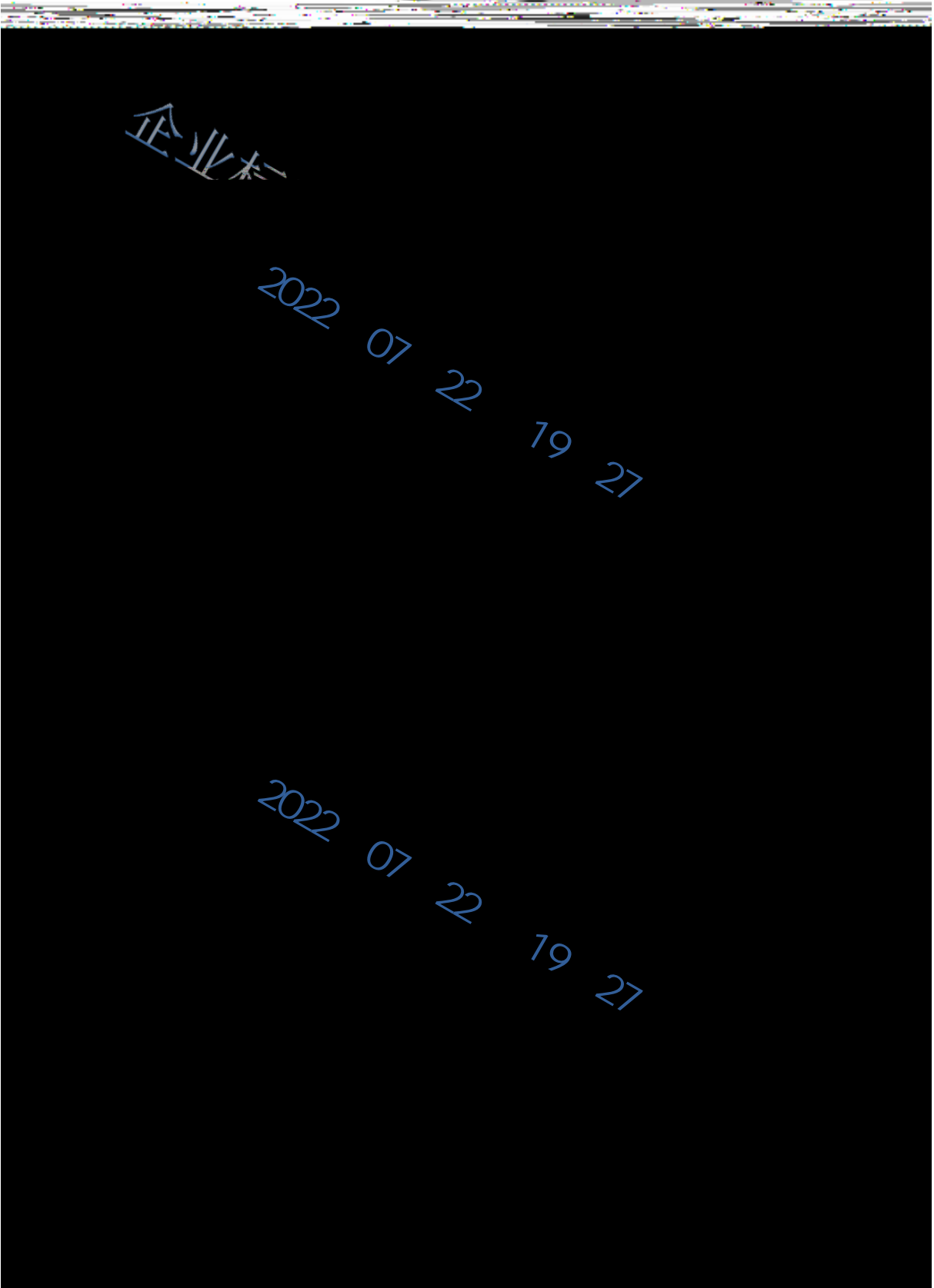

企业本

2022 07 22 19 27

2022 07 22 19 27







K  
( )

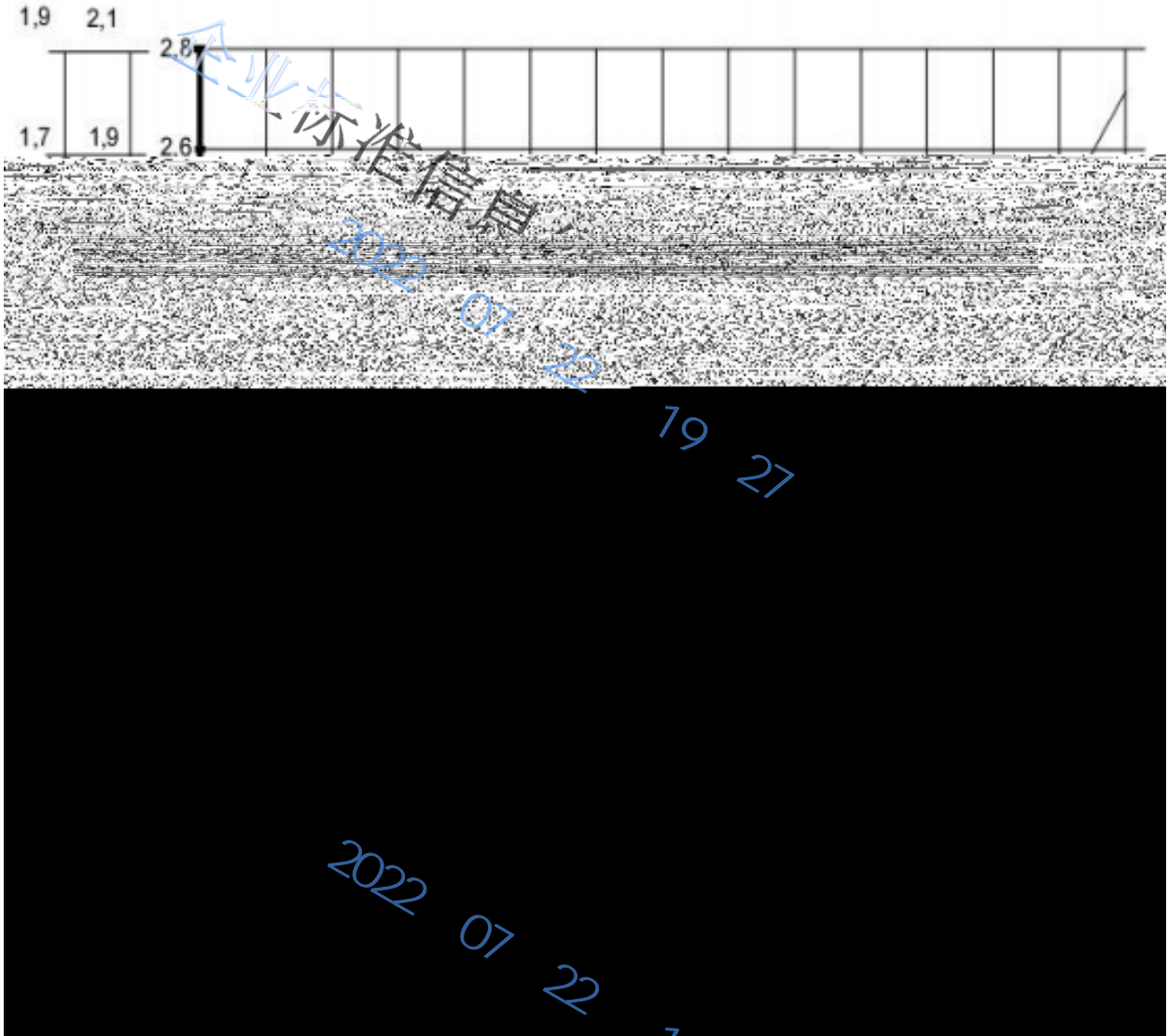

$\frac{m/s}{m}$   
 H  
 \*  
 5 7.3 1  
 \*\* 5 7.1. 4  
 3 5m/s  
 K1 (5.7.1)



( L )

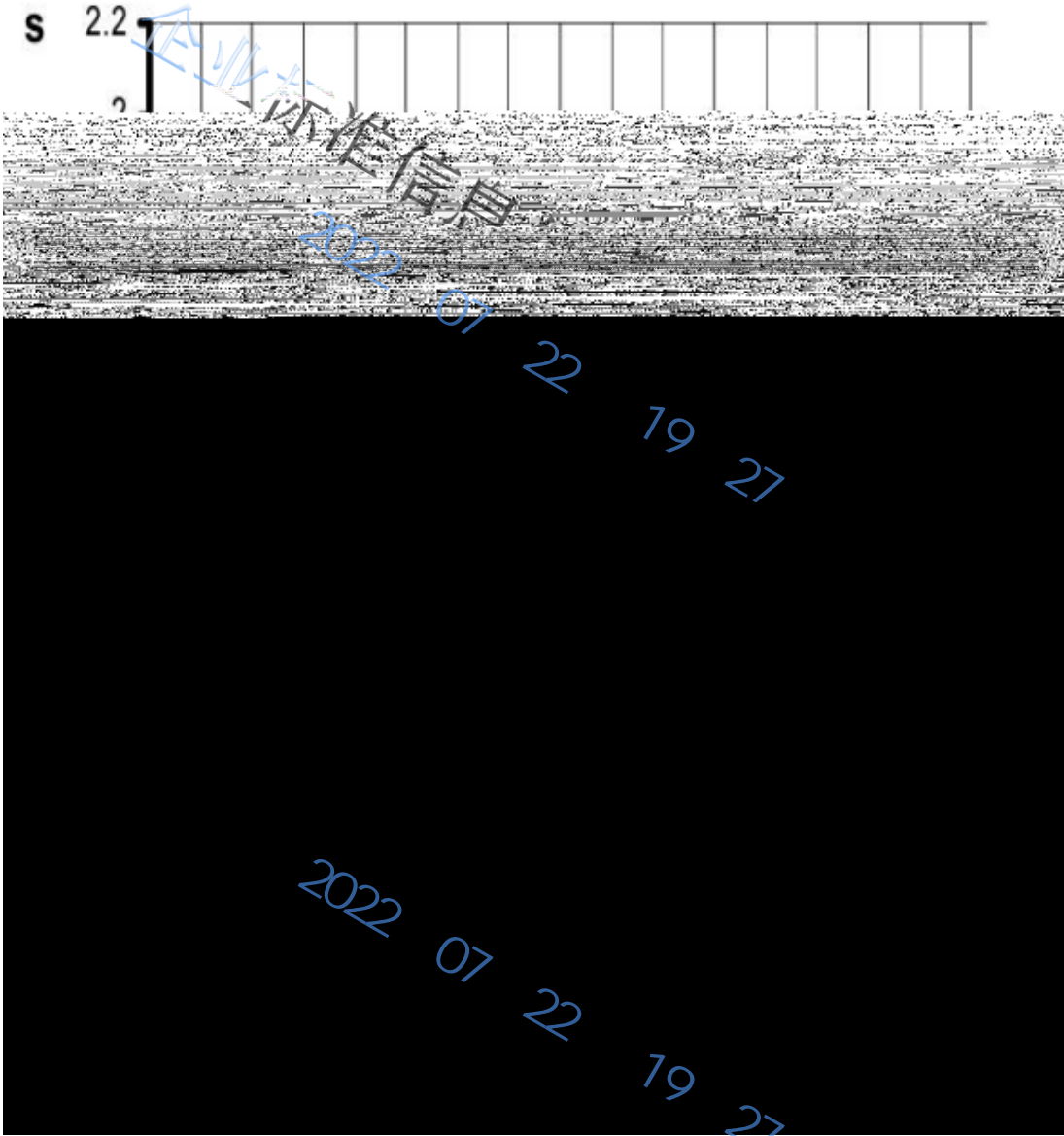

S

m

m/s

( 10 4 1. 1 ) ( )

( 10 4 3 1 )

50%

[ 10 4 3 2a ]

1/3

[ 10 4 3 2b ]

10 4 3

L1

( 10 4 )



( M )

M

- a)
- b)
- c)

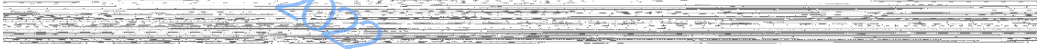

企业标准信息

2022 07 22 19 27

- a)
  - b)
  - c)
  - d)
- ∅

$T_1 < \dots$

$T_1 < \dots$

( )

2022 07 22 19 27

f

a

T1 T2

∅ 1 T1 T2

∅ 1.1

T1/T2

125%

1.25

8 2 2

8 2 2

∅ 1.2



T1/T2

a)

0.5 m/s<sup>2</sup>

b)

0.8 m/s<sup>2</sup>

M 1.3

T1/T2

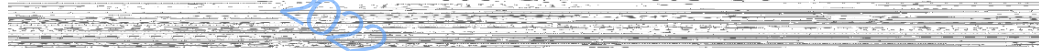

M 2

M 2.1

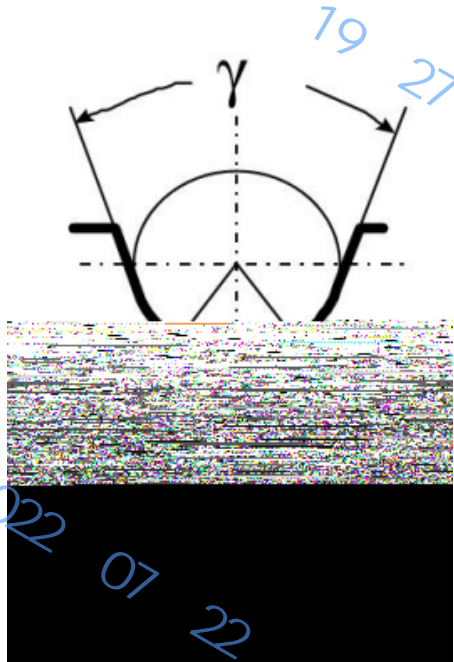

$$f = \mu \cdot \frac{4 \left( \cos \frac{\gamma}{2} - \sin \frac{\beta}{2} \right)}{\pi - \beta - \gamma - \sin \beta + \sin \gamma}$$

$\mu$

1060(1.83 )

80%



)  
M2 1.2 V

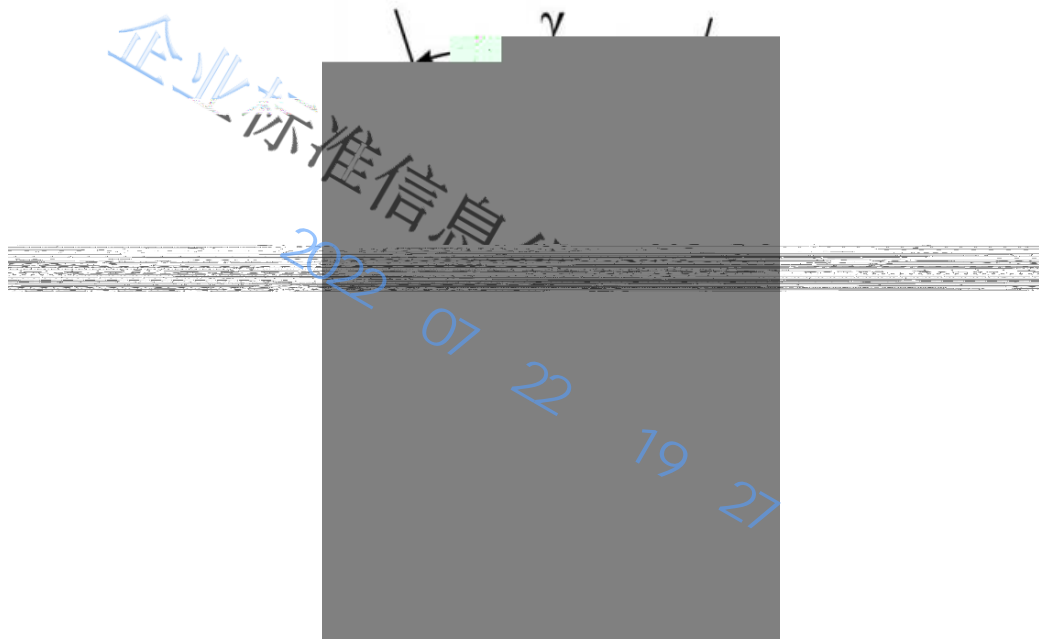

$$f = \mu \cdot \frac{4 \left( 1 - \sin \frac{\beta}{2} \right)}{\pi - \beta - \sin \beta}, \text{ 对于未经硬化处理的槽;}$$

$$f = \mu \cdot \frac{1}{\sin \frac{\gamma}{2}}, \text{ 对于经硬化处理的槽;}$$

——轿厢滞留的工况:



1060(1.83 )

80%

350

M2 2 2



0.12

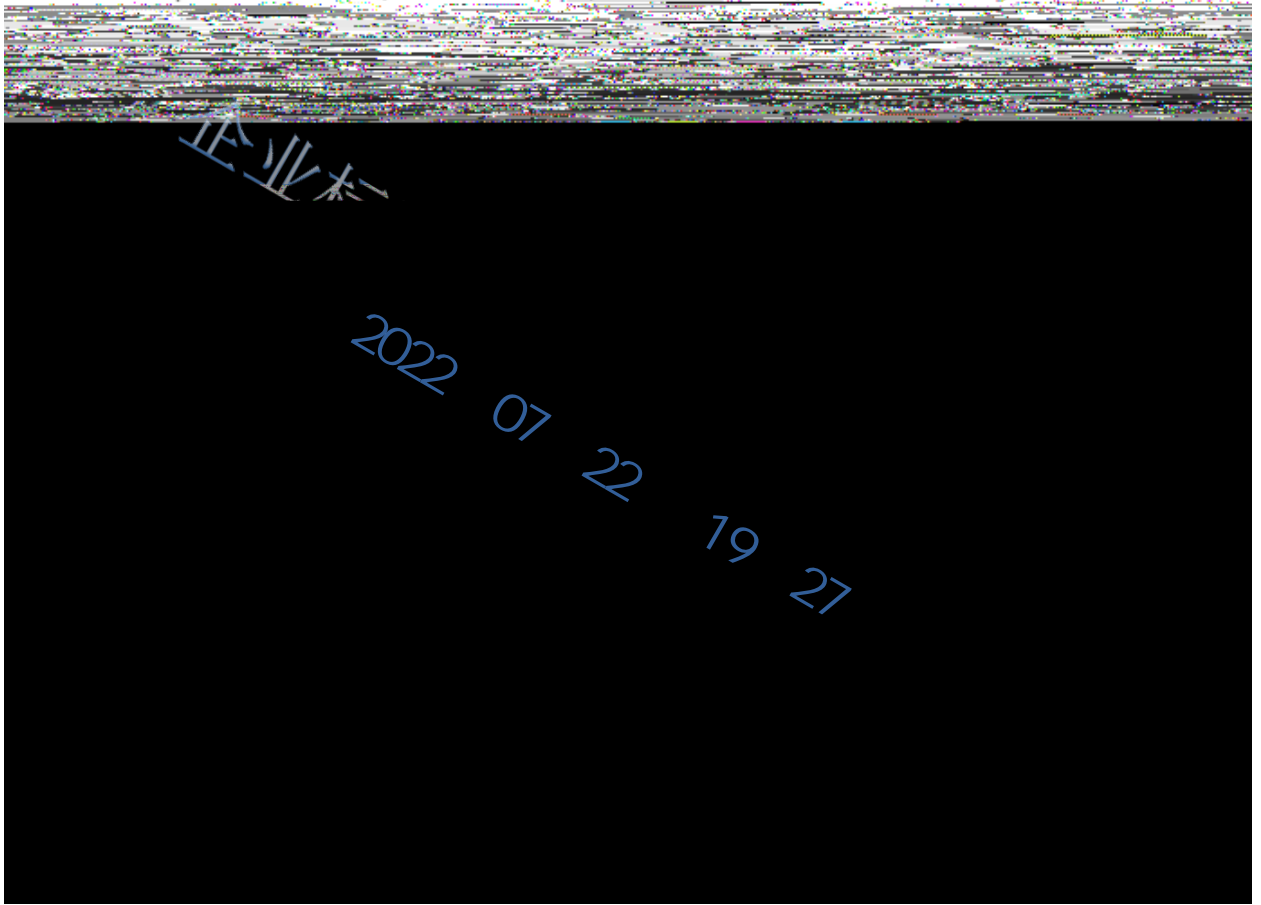

$\mu = 0,2$

MB

2022 07 22 19 27

ms

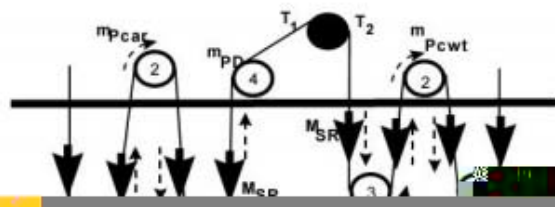

企业标准信息

2022 07 22 19 27

2022 07 22 19 27

1

1

$n_{pcar}$	$J_{pcar}/R^2$	kg	
$n_{Pcwt}$	$J_{Pcwt}/R^2$	kg	
$n_{PID}$	$(2 \quad ) J_{PID}/R^2$		kg
$n_{IP}$	$J_{IP}/R^2$	kg	



ns

nc ( )

nt

P

( ) ( )

kg

Q

kg

Mwt

kg

MR

$[(0.5H - y) \times ns \times$

] kg

MRcar

MR

MRcwt

MR

MR

( )

$[(0.5H - y) \times nc \times$

]

kg

MRcar

MR

MRcwt

MR

Mrav

$[(0.25H - 0.5y) \times nt \times$

]

Momp

kg

FRcar

(

) N

FRcwt

(

) N

H

m

y

H/2

m

T1

T2

N

r

( ) m/s<sup>2</sup>

gn

m/s<sup>2</sup>

iPcar

(

)

iPcwt

(

)

f

a





( N )

Nl

9.2.2

St

a)

( )

b)

c)

N2

N<sub>equi v</sub>

(U V )

5% 6%

N<sub>equi v</sub>

$$N_{equi v} = N_{equi v}(t) + N_{equi v}(p)$$

N<sub>equi v</sub>(t)

N<sub>equi v</sub>(p)

N2.1 N<sub>equi v</sub>(t)

N<sub>equi v</sub>(t)

Nl

U

N<sub>equi v</sub>(t) 1

表 N1

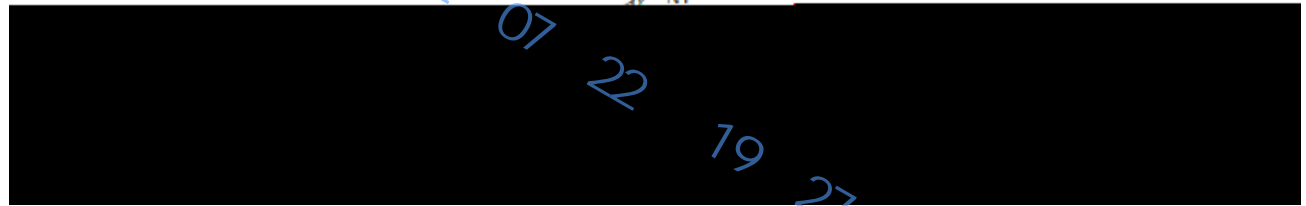

N2.2 N<sub>equi v</sub>(p)

200

$$N_{equi v}(t) = K_p (N_{ps} + 4 \cdot N_{pr})$$

N<sub>ps</sub>

N<sub>pr</sub>

K<sub>p</sub>



Dt  
Dp  
N3

Dt/dr

N4

$N_{equiv}$

$N_2$

例 1.

V 型槽,  $\gamma=40^\circ$

$N_{equiv(t)} = 7.1$

$K_p = 2.07$

$N_{equiv(p)} = 2 \times 2.07 = 4.1$

$N_{equiv} = 11.2$

轿厢侧

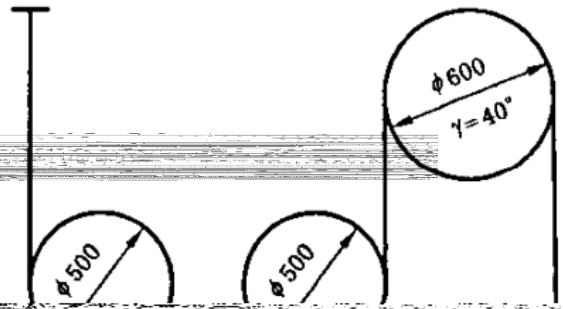

例 2.

V 型带切口槽

$\gamma=40^\circ$

$\beta=90^\circ$

$N_{equiv(t)} = 5.0$

$K_p = 5.06$

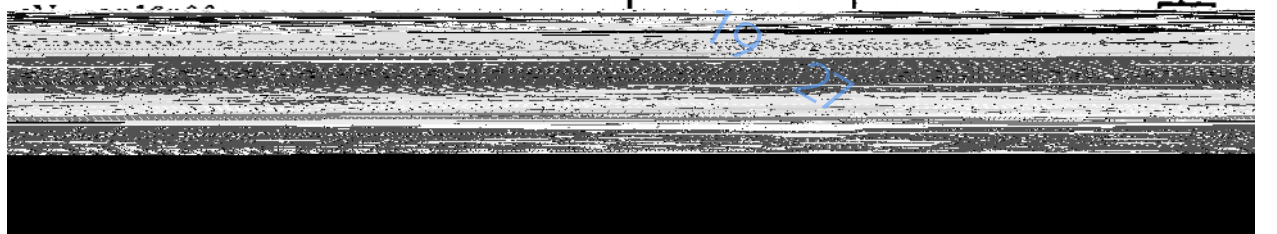
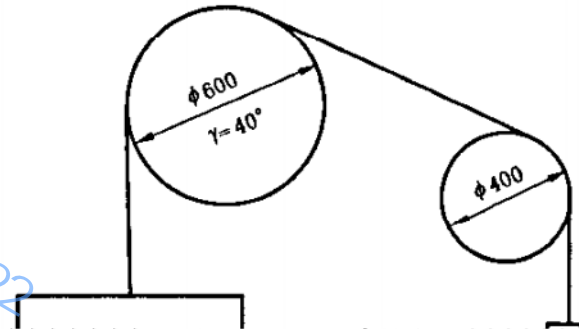

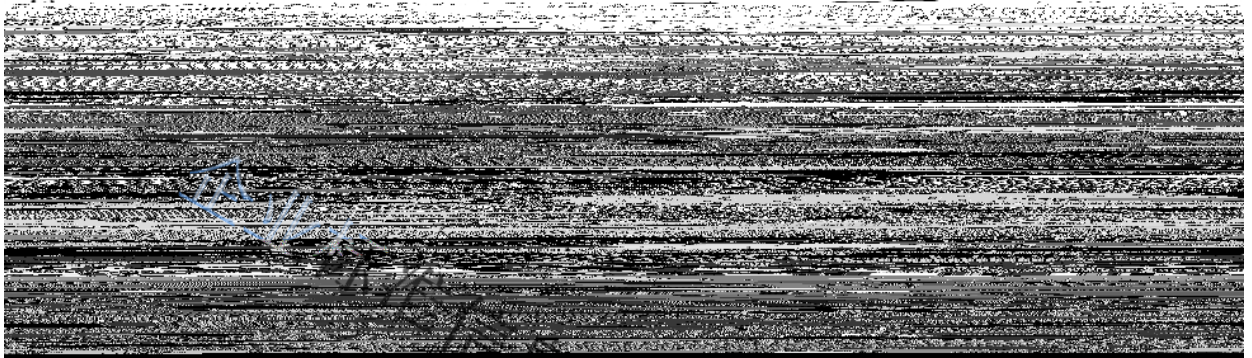

2022 07 22 19 27

2022 07 22 19 27